

TECHNICAL GUIDE



WELCOME TO THE REAL ALUMINIUM TECHNICAL GUIDE

This technical guide contains all the details and information you need to easily specify REAL Aluminium.

As part of Customade Group and as a leading fabricator of Smart Architectural Aluminium, REAL Aluminium offer a complete range of high-end aluminium windows and doors for the trade. All REAL Aluminium products can be specified to Part Q if required and our in-house team are always on hand to provide help and advice with your products.



GET IN TOUCH

For further technical advice and enquiries regarding the REAL Aluminium range, please contact us on:

Telephone: **01453 826884**

Email: **enquiries@real-aluminium.co.uk**

Website: **www.re-aluminium.co.uk**

CASEMENT WINDOW

ASSEMBLY DRAWINGS

Alitherm 400x – Contemporary Frame – Slim Sash	Page 4
Alitherm 400i – Contemporary Frame – Medium Sash	Page 5
Alitherm 400 Tilt and Turn	Page 8
Alitherm 400 Flush Sash	Page 9

MAIN PROFILES

Alitherm 400 Window Systems i and x	Page 6-7
-------------------------------------	----------

ANCILLARIES

Alitherm 400 Ancillaries	Page 10
--------------------------	---------

RESIDENTIAL OR FRENCH DOOR

ASSEMBLY DRAWINGS

Alitherm 400 Quick-Glaze System	Page 12-14
Alitherm 400 Couplers	Page 15

MAIN PROFILES

Alitherm 400 Door System	Page 11
--------------------------	---------

HERITAGE RANGE

ASSEMBLY DRAWINGS

Heritage Window	Page 16
Heritage Door	Page 18-10

MAIN PROFILES

Heritage Window	Page 17
Heritage Door	Page 20

COMPOSITE OR BI-FOLDING DOOR

ASSEMBLY DRAWINGS

New Visofold SLIM 1000 Quickglaze Bi-folding Door - Jamb & Mullion Details	Page 21
New Visofold SLIM 1000 Quickglaze Bi-folding Door - Head & Threshold Details	Page 22

MAIN PROFILES

Visofold SLIM 1000 Quickglaze	Page 23
-------------------------------	---------

SLIDING DOOR

ASSEMBLY DRAWINGS

Visoglide Plus (Two Track) - Jamb Details	Page 24
Visoglide Plus (Three Track) - Trickle Vent, Head & Threshold Details – With Standard Frame	Page 25
Visoglide Plus (Three Track) - Head & Threshold Details – With Internal Upstand Frame	Page 26
Visoglide Plus - Mullion Details	Page 27
Visoglide Plus - Reinforced Mullion Details	Page 28
Visoglide Plus - Flush Stacking	Page 29
Visoglide Plus - Slim Interlock Details	Page 30

MAIN PROFILES

Visoglide Plus	Page 31
----------------	---------

OTHER TECHNICAL INFORMATION

Non-Stock Colour Options	Page 32 - 34
Stock Colour Options	Page 34
Part L and Part F Building Regulations	Page 35
Replacement on Existing Dwellings or Extensions (Energy Ratings)	Page 36
Extensions U Values (Limiting U Value 1.4 W/m ² k)	Page 37
New Build U Values with Double Glazing (Limiting U Value 1.6 W/m ² k)	Page 38
New Build U Values with Triple Glazing Notional Method (Target U Value 1.2 W/m ² k)	Page 39
AD L: Energy Efficiency - New Dwellings	Page 40
Fresher, Cleaner Indoor Air (PART F)	Page 41
Building Regulation Compliance, Window Energy Ratings (WER) and Doorset Energy Ratings (DSER)	Page 42
Product Specifications	Page 43

Casement Window Assembly Drawings

Alitherm 400x

Contemporary Frame | Externally Glazed | Flat Sash

Note: Wedge gasket is standard on externally glazed windows

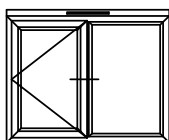

- ETC4110 - Outer Frame
- ETC4120 - Z-Sash
- ETC4130 - T-Transom/Mullion
- ETC4179G - 28mm Glazing Z sash
- UN3160G - 28mm Glazing
- ETC458 - 190mm Sill
- UN3042 - Outer Frame Extension

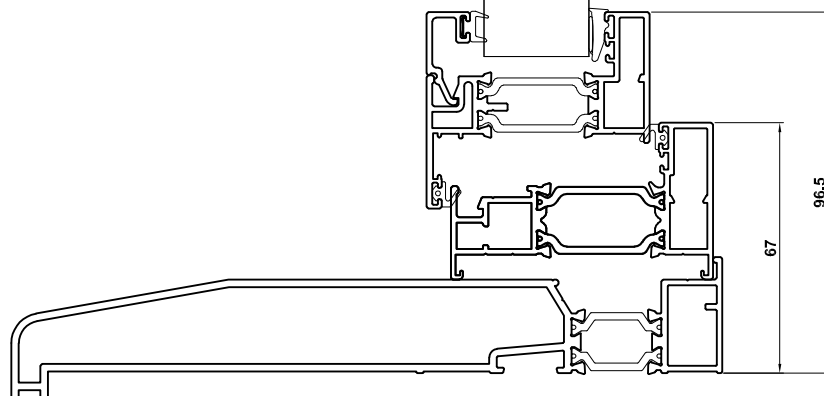
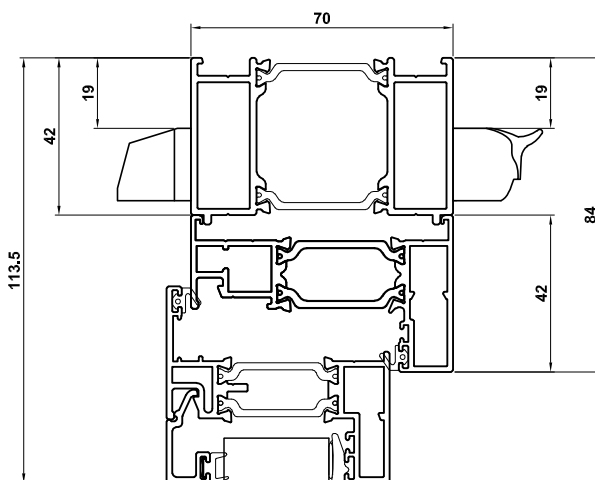
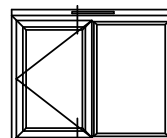
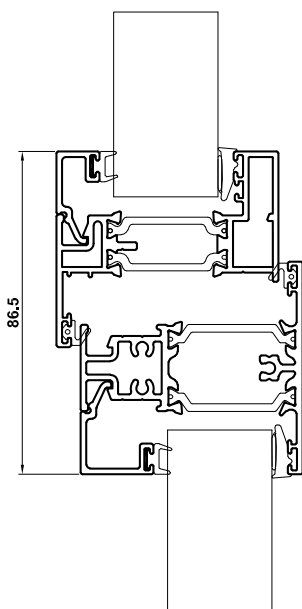

Casement Window Assembly Drawings

Alitherm 400i Quick-Glaze System

Contemporary Frame | Internally Glazed | Flat Sash | Quickglaze Bead

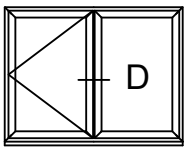

ETC4110 - Outer Frame
ETC4124 - Slim T-Sash
ETC4130 - T-Transom/Mullion
UN3160G - 28mm Glazing
ETC458 - 190mm Sill

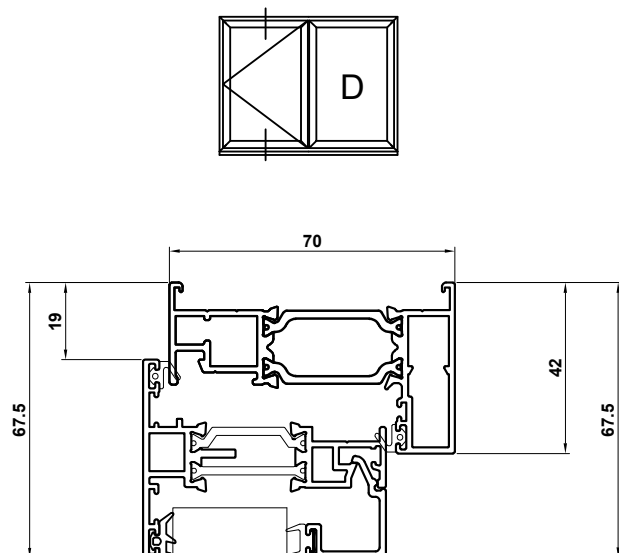
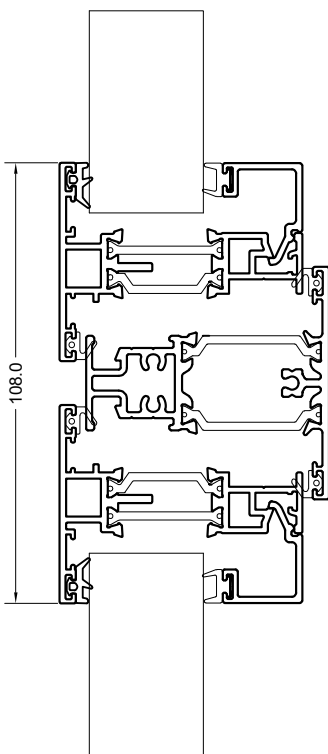

Note:

Fixed panes on Alitherm 400i always have dummy sashes

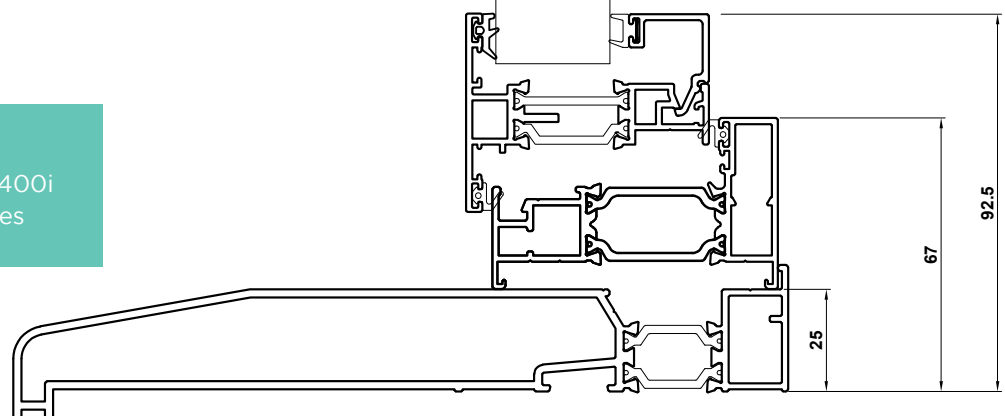

Casement Window Main Profile

Alitherm 400 Window Systems i and x

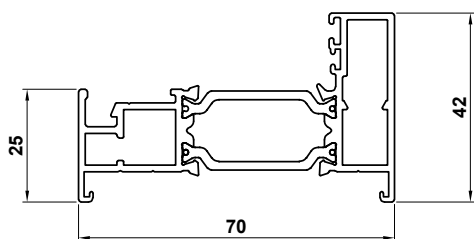

ETC4110
Square Outer Frame

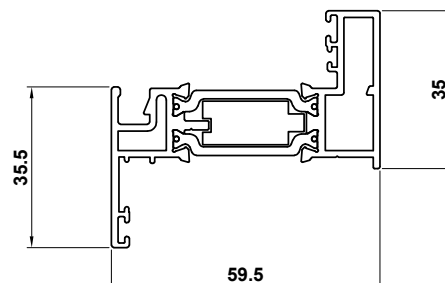

ETC4120
Externally Beaded Z Sash
(Crimp Only)

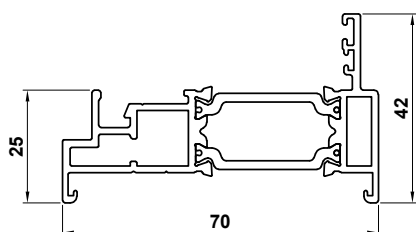

ETC4115
Flush sash outer frame

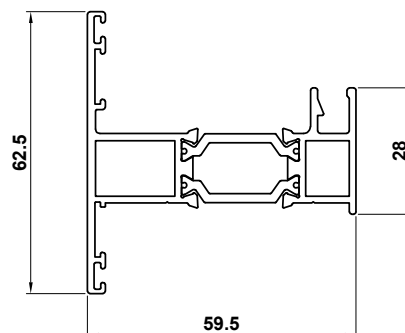

ETC4129
Internally Bead T Sash

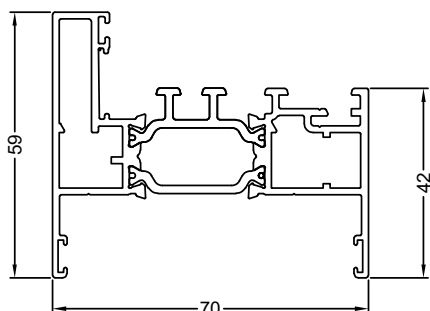

ETC4014
Tilt & Turn Outer Frame

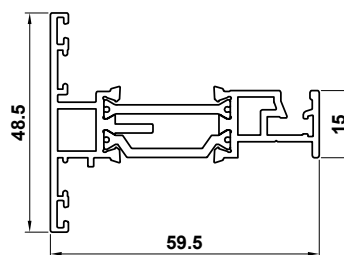

ETC4124
Internally Bead Slim T Sash

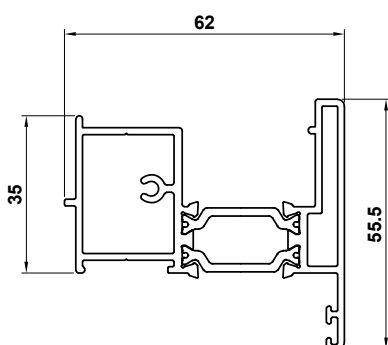

ETC4138
French Casement Mullion

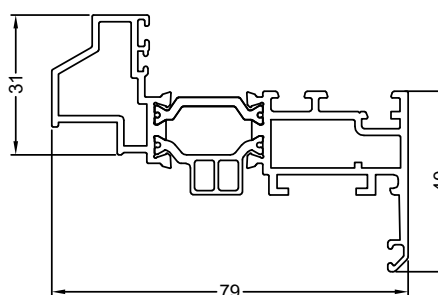

ETC4021
Tilt & Turn Sash

Casement Window Main Profile

Alitherm 400 Window Systems i and x

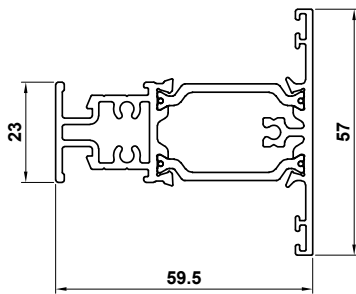

ETC4130
Transom/Mullion

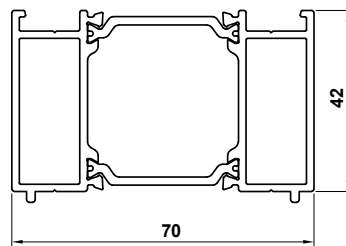

UN3042
70mm x 42mm Head Extension

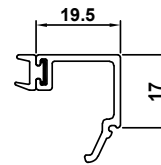

UN3160G
28mm Glazing Bead
with Gasket

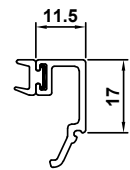

ETC4179G
28mm Glazing Z sash
Bead

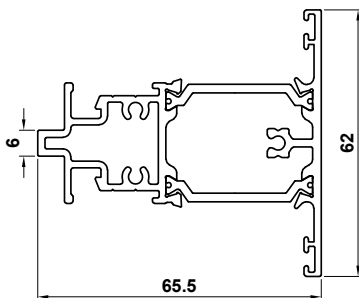

ETC4135
Flush sash Transom / Mullion

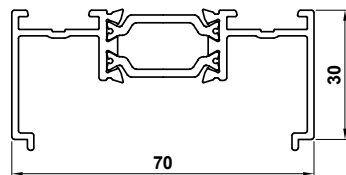

UN3370
70mm x 30mm Frame Extension

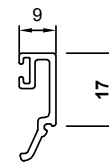

UN3166
40mm Glazing Bead

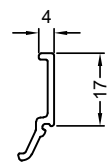

UN3168
44mm Glazing Bead

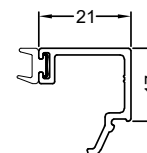

ETC4067G
Tilt & Turn
28mm Glazing Bead

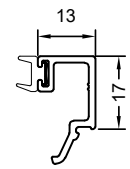

ETC4061G
Tilt & Turn
36mm Glazing Bead

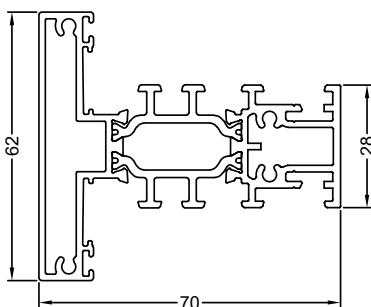

ETC4031
Tilt & Turn T-transom / mullion

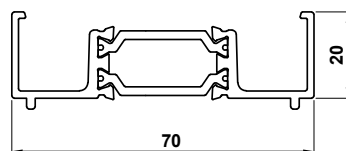

UN3020
70mm x 20mm Frame Extension

Tilt and Turn Window Assembly Drawings

Alitherm 400

Contemporary Frame | Internally Glazed | Featured Sash

Note: Wedge gasket is standard on internally glazed windows

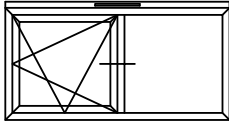

- ETC4014 - Outer Frame
- ETC4021 - Sash
- ETC4031 - T-Transom/Mullion
- ETC4067 - 28mm Glazing Bead
- ETC458 - 190mm Sill
- UN3020 - Outer Frame Extension

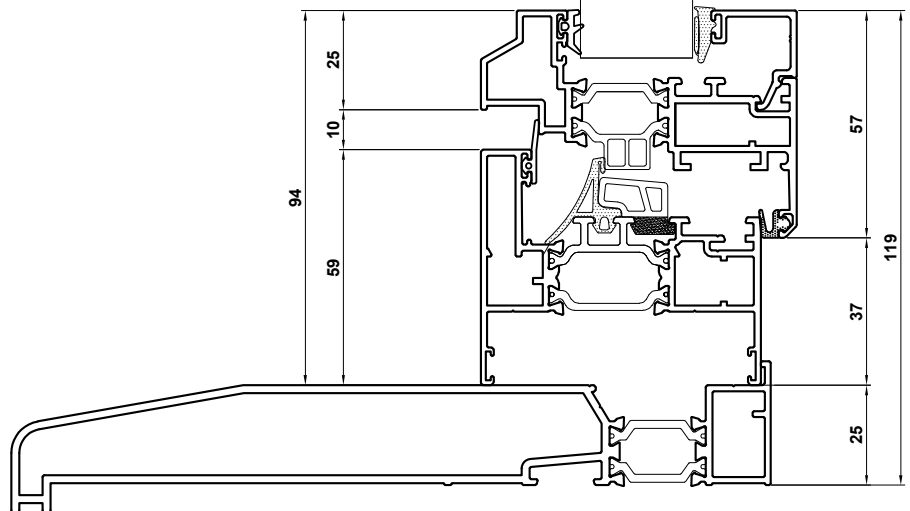
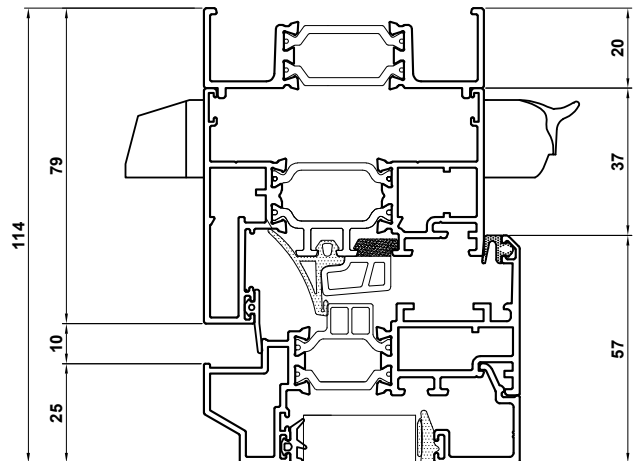
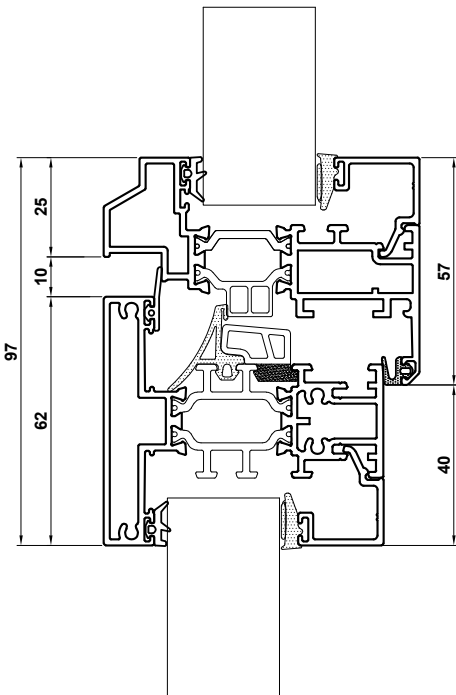
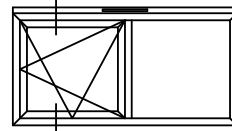

Flush Sash Window Assembly Drawings

Alitherm 400

Contemporary Frame | Internally Glazed | Flat Sash

Note: Wedge gasket is standard on internally glazed windows

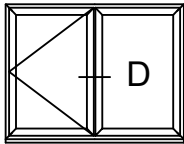

ETC4115 - Outer Frame
ETC4124 - Sash
ETC4135 - T-Transom/Mullion
UN3160G - 28mm Glazing Bead
ETC458 - 190mm Sill

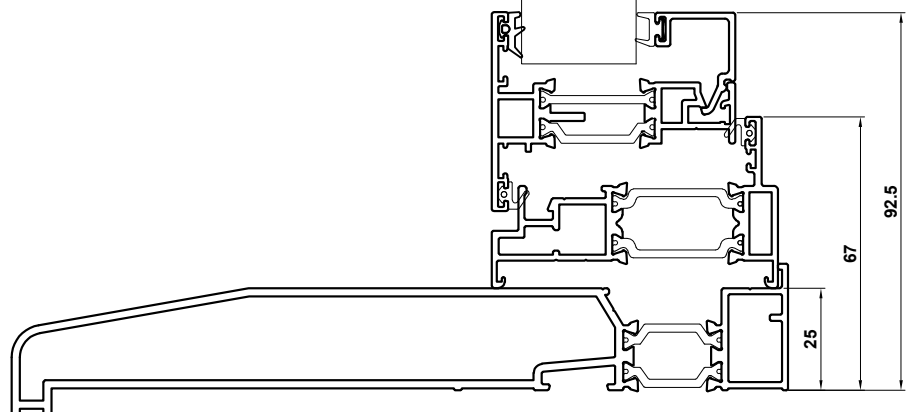
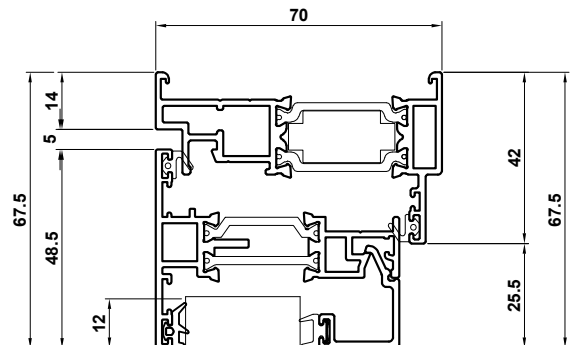
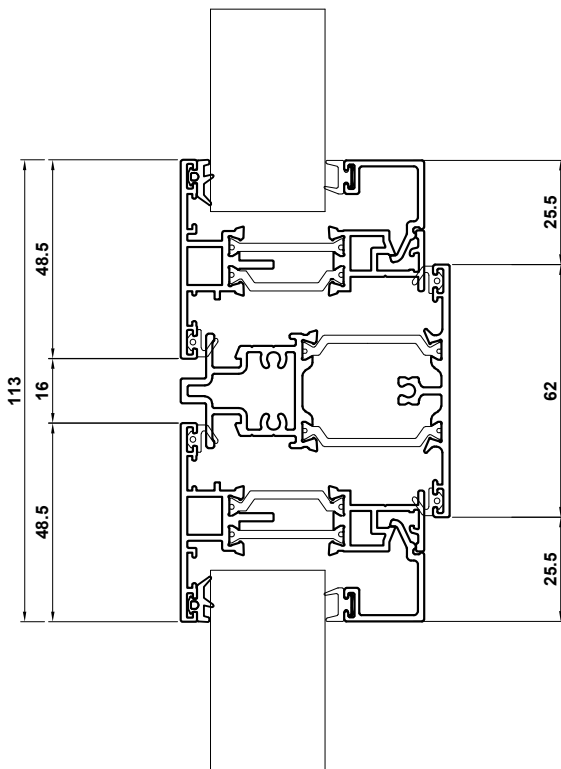
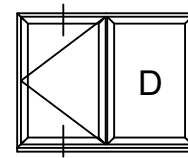

Casement Window Ancillaries

Alitherm 400 Window Systems i and x

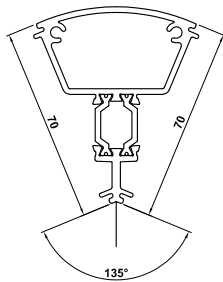

UN3011
135° Corner Post

Note:
All posts are not structural or load bearing.

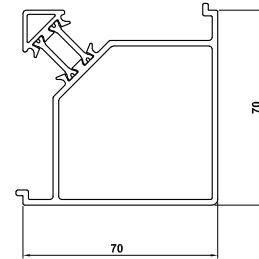

UN3010
70mm Corner Post

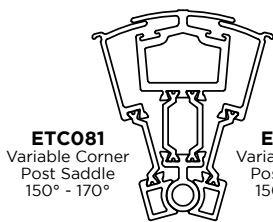

ETC081
Variable Corner Post Saddle
150° - 170°



ETC081
Variable Corner Post Saddle
150° - 170°

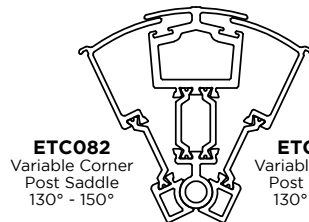

ETC082
Variable Corner Post Saddle
130° - 150°



ETC082
Variable Corner Post Saddle
130° - 150°

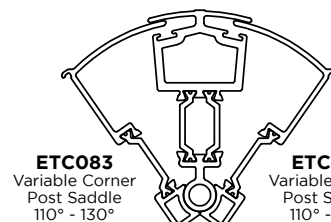

ETC083
Variable Corner Post Saddle
110° - 130°



ETC083
Variable Corner Post Saddle
110° - 130°



ETC080
Variable Corner Post Centre



ETC080
Variable Corner Post Centre



ETC080
Variable Corner Post Centre

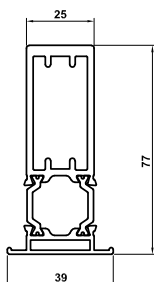

ETC517
Coupler



W20165
Astragal Bar

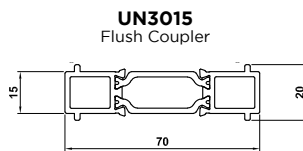

UN3015
Flush Coupler

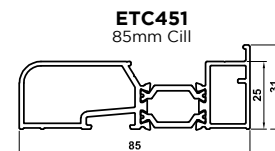

ETC451
85mm Cill

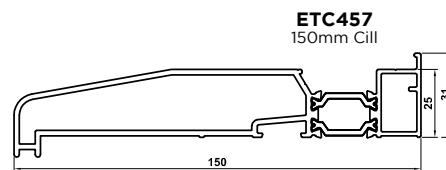

ETC457
150mm Cill

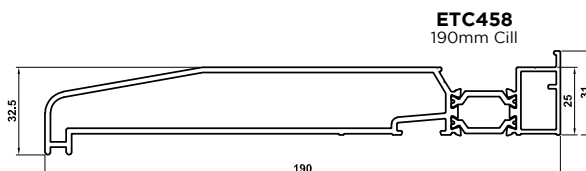

ETC458
190mm Cill

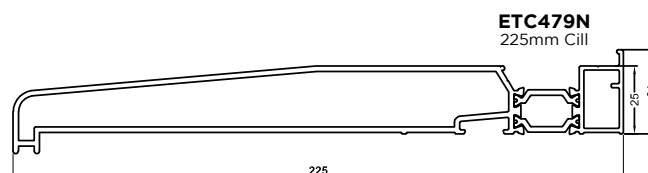

ETC479N
225mm Cill

Residential or French Door Main Profiles

Alitherm 400 Door System

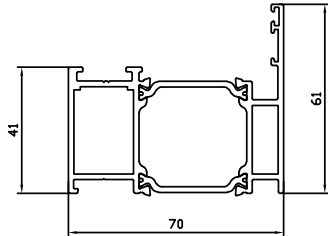

ETD410
Outer Frame

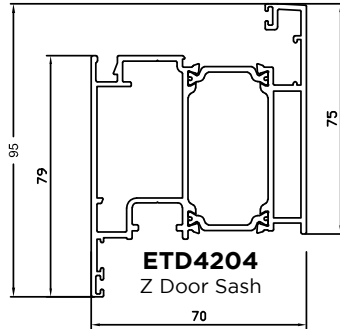

ETD4204
Z Door Sash

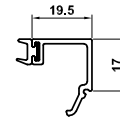

UN3160G
28mm Glazing
Bead with
Gasket

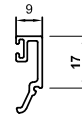

UN3166
40mm Glazing
Bead

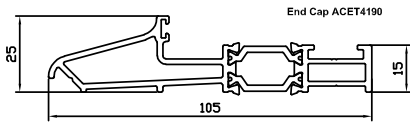

ETD490
Low Threshold Open In

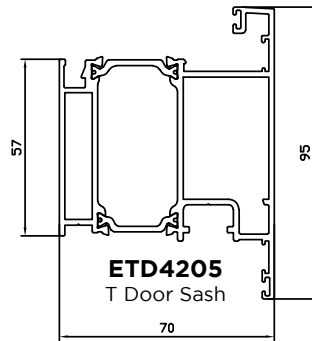

ETD4205
T Door Sash

End Cap ACET4197



UL297
Sash Adaptor
in Conjunction
with ETD490
and ETD492
Low Threshold



VL72
Weather Drip

End Cap ACVL059
Rivet: ACVL061

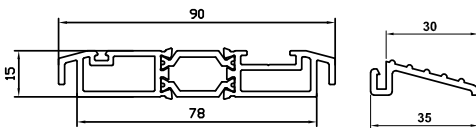

ETD495
Low Threshold Ramp

EUD03
Low
Threshold
Ramp

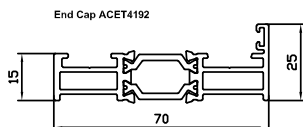

ETD492
Open Out Low Threshold

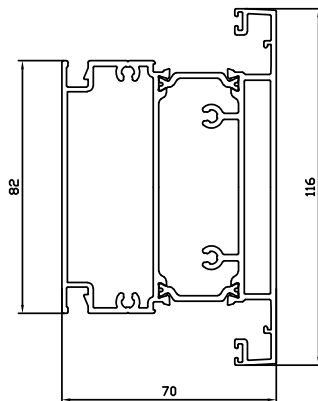

ETD 4301
Midrail for ETD4204

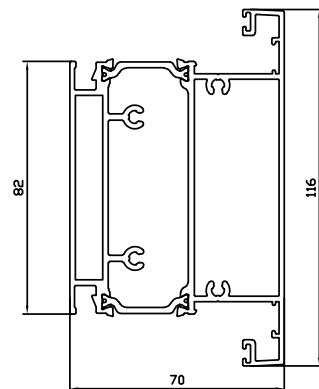

ETD 4302
Midrail for ETD4205

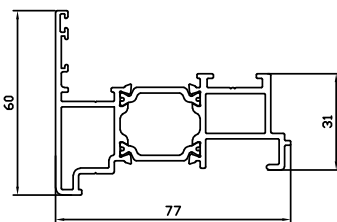

ETD447
Dummy Mullion

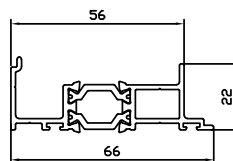

ETD496
Adaptor for Ramp Threshold



PCX15
Clip on
for Sash



PCX47
Clip on for
Thresholds

End Cap ACET4142 used with ETD495
ACE4146 used with ETD490 AND ETD492
ACE4147 used with ETD410

Residential or French Door Assembly Drawings

Alitherm 400 Quick-Glaze System

Resi Door | Open In | Internally Glazed

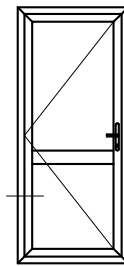

ETD410 - Outer Frame
ETD4204 - Z-Sash
UN3160G - 28mm Glazing

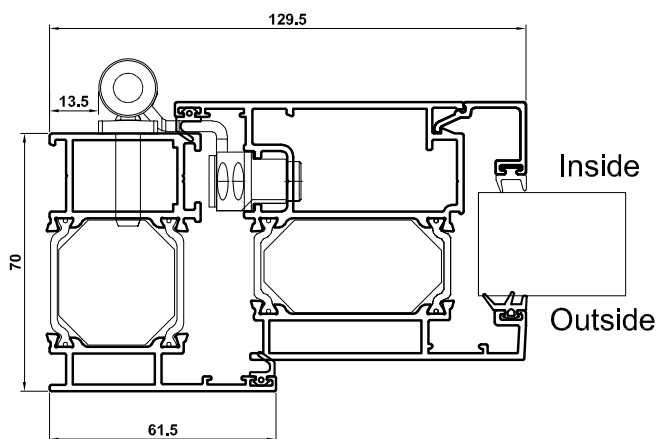

Alitherm 400 Quick-Glaze System

French Door | Open Out | Internally Glazed

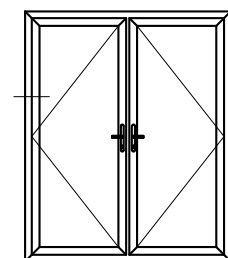

ETD410 - Outer Frame
ETD4205 - T-Sash
UN3160G - 28mm Glazing

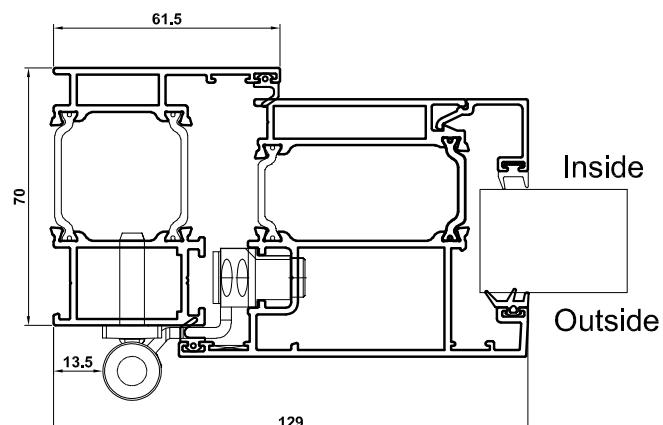

Residential or French Door Assembly Drawings

Alitherm 400 Quick-Glaze System

Resi Door | Open In | Internally Glazed | Midrail

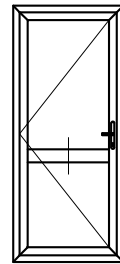
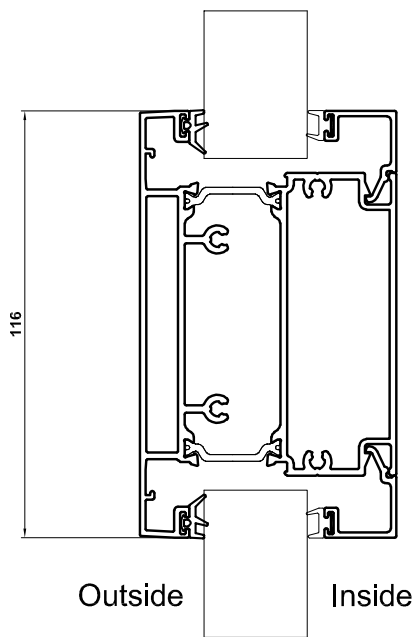

ETD4301 - Midrail
UN3160G - 28mm Glazing

Alitherm 400 Quick-Glaze System

French Door | Open Out | Internally Glazed

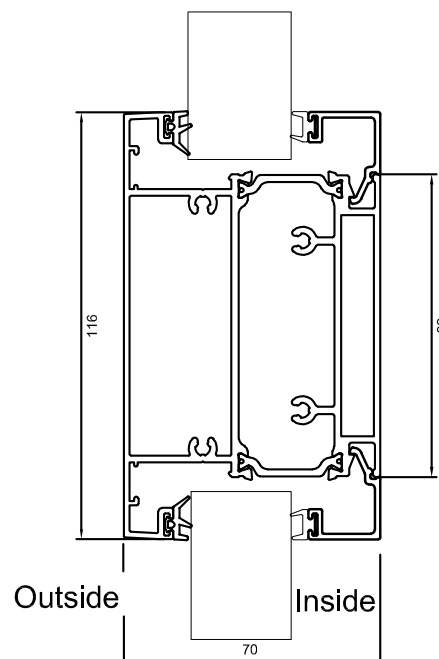
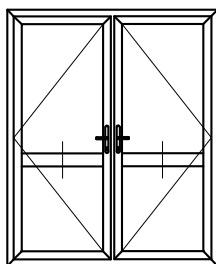

ETD4302 - Midrail
UN3160G - 28mm Glazing

Residential or French Door Assembly Drawings

Alitherm 400 Quick-Glaze System

French Door | Open Out | Internally Glazed

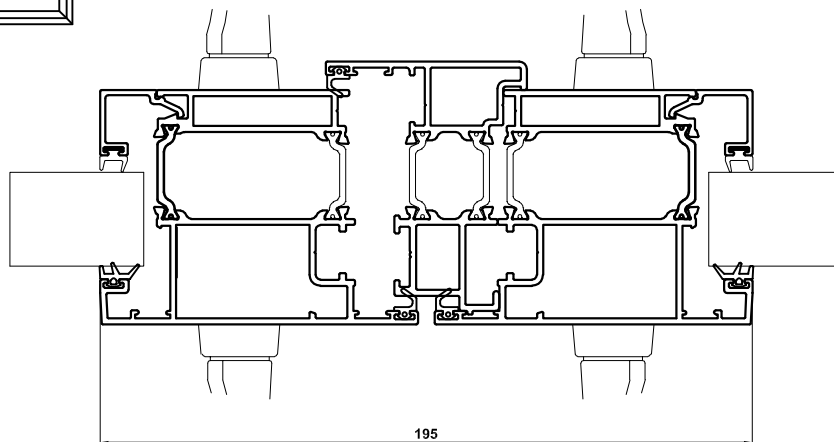
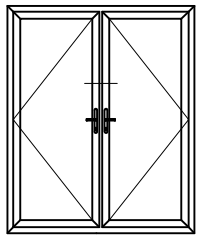

ETD4205 - T-Sash
ETD447 - Dummy Mullion
UN3160G - 28mm Glazing

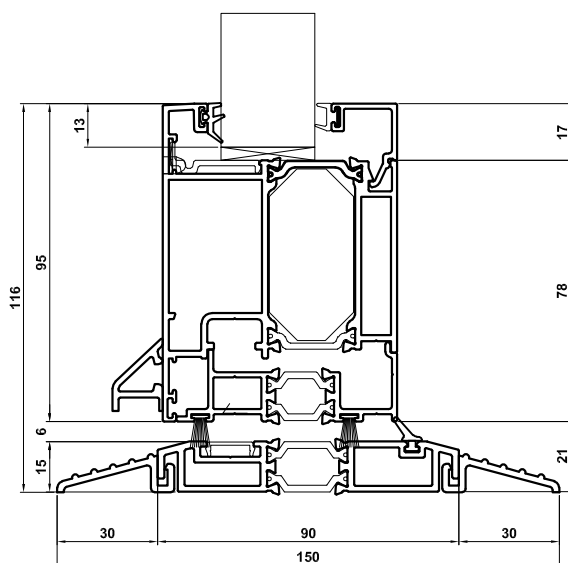
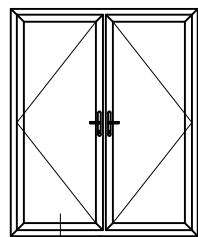

ETD4205 - T-Sash
UN3160G - 28mm Glazing
ETD495 - Low Threshold
ETD496 - Adaptor for Ramp Threshold
EUD03 - Low Threshold Ramp

Residential or French Door Assembly Drawings

Alitherm 400

Couplers

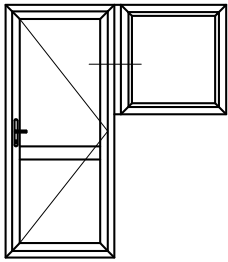

Flush Coupler

ETD410 - Outer Frame
ETD4204 - Z Sash
UN3160G - 28mm Glazing
UN3015 - Flush Coupler
ETC4110 - Outer Frame

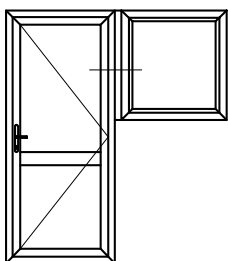
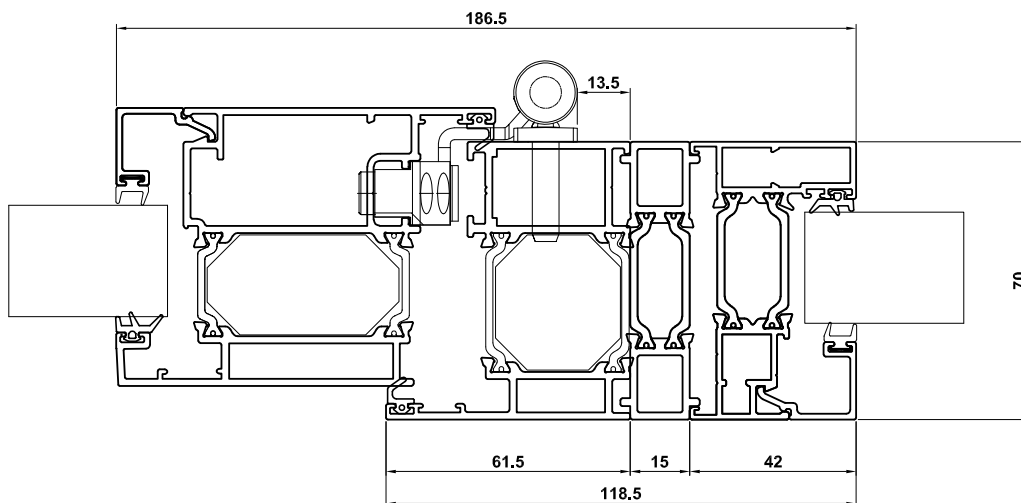

Heavy Duty 25mm Coupler

ETD410 - Outer Frame
ETD4204 - Z Sash
UN3160G - 28mm Glazing
ETC517 - 25mm Heavy Duty Coupler
ETC4110 - Outer Frame

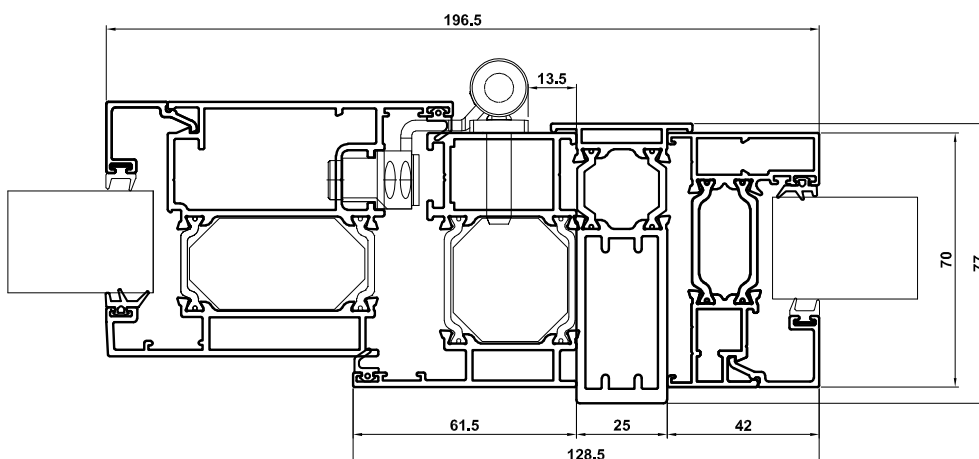

Heritage Windows Assembly Drawings

W20015 - Outer Frame
W20025 - Sash
W20171N - 28mm Glazing Bead
ETC457 - 150mm Sill

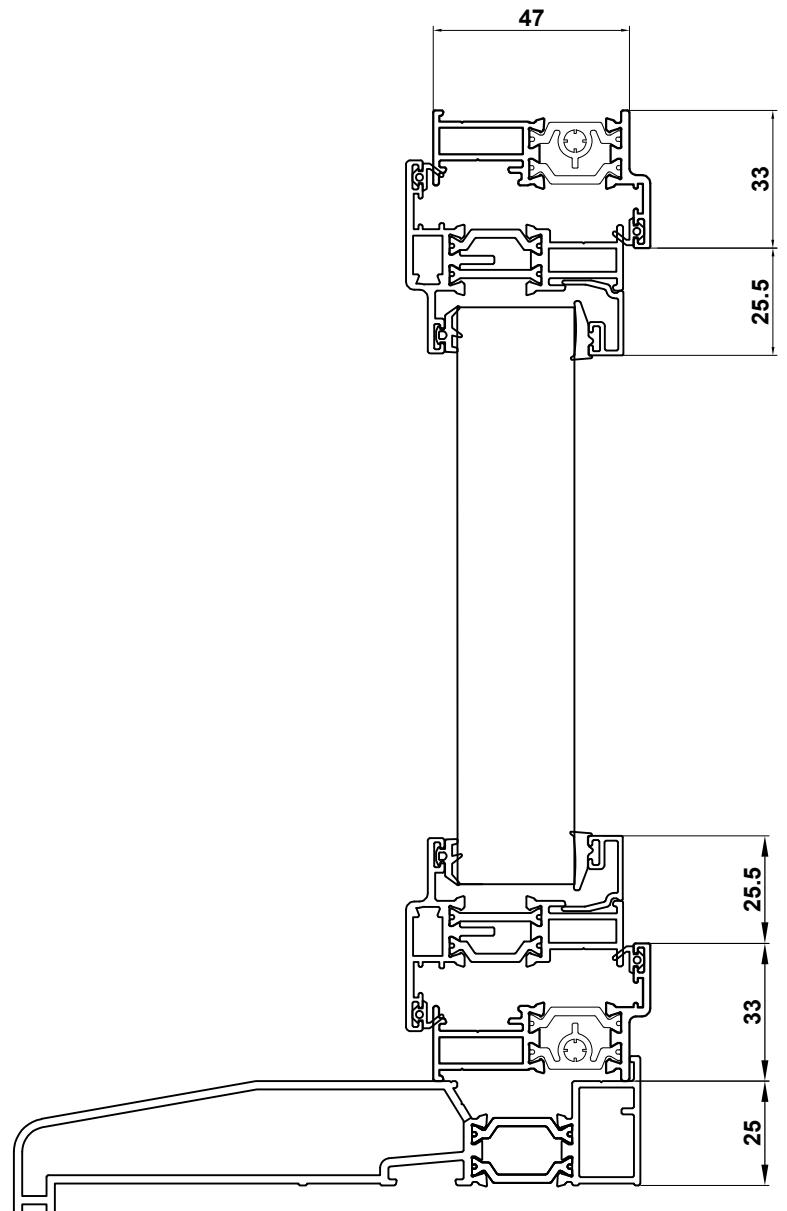
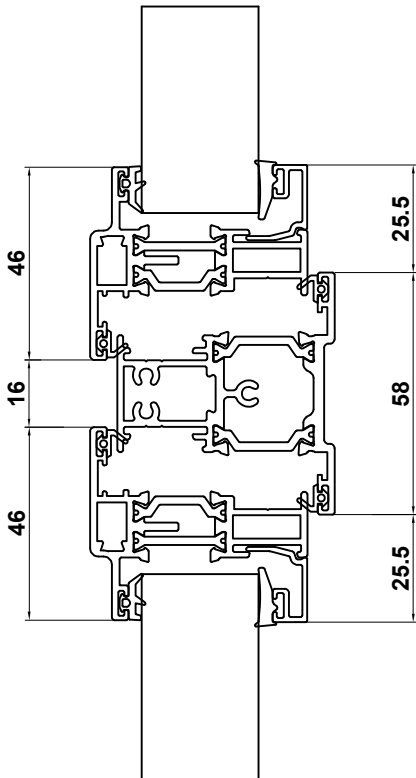
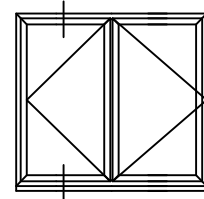
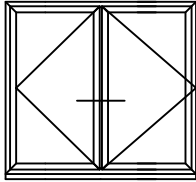

Heritage Windows Main Profile

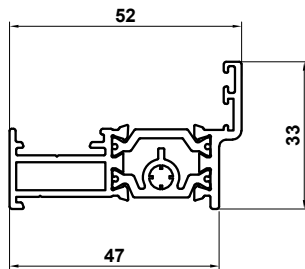

W20015
47mm outer frame

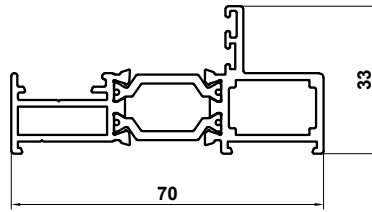

W20017
70mm outer frame

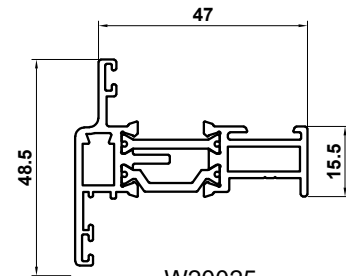

W20025
Sash

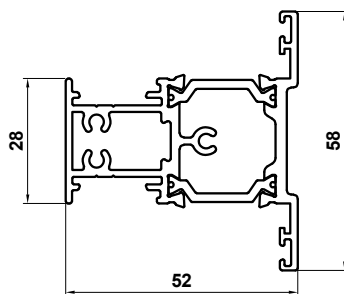

W20034
Mullion/Transom

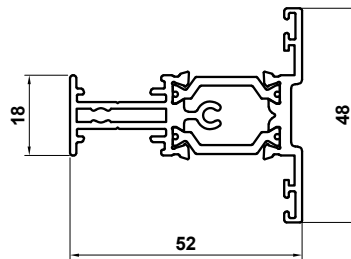

W20035
Slim Transom

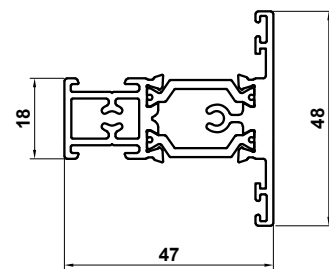

W20133
Sash transom

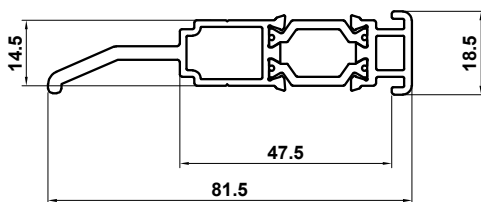

W20485
horizontal coupler with drip

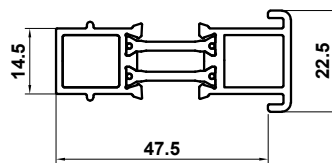

W20489
coupler

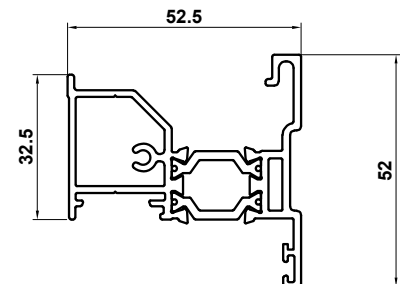

W20244
French casement mullion

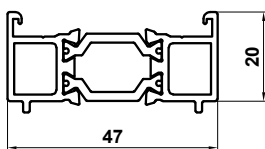

ETD056
20mm add on

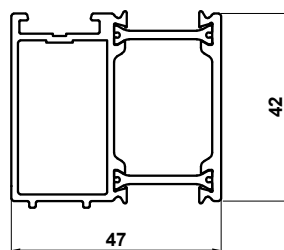

ETD058
42mm add on

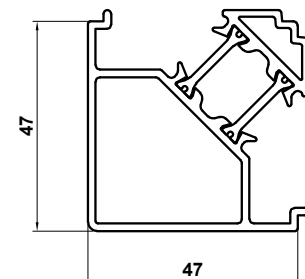

ETC047
Corner Post

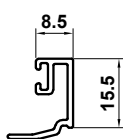

W20171N
28mm glazing bead

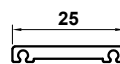

W20165
25mm astragal bar

Heritage Doors Assembly Drawings

Heritage 60 Standard Threshold

Heritage 60 Open In
W20415 - Outer Frame
W20429 - Open In Sash
W20469 - 28mm Glazing Bead
ETC457 - 150mm Sill

Heritage 60 Open Out
W20415 - Outer Frame
W20424 - Open Out Sash
W20469 - 28mm Glazing Bead
ETC457 - 150mm Sill

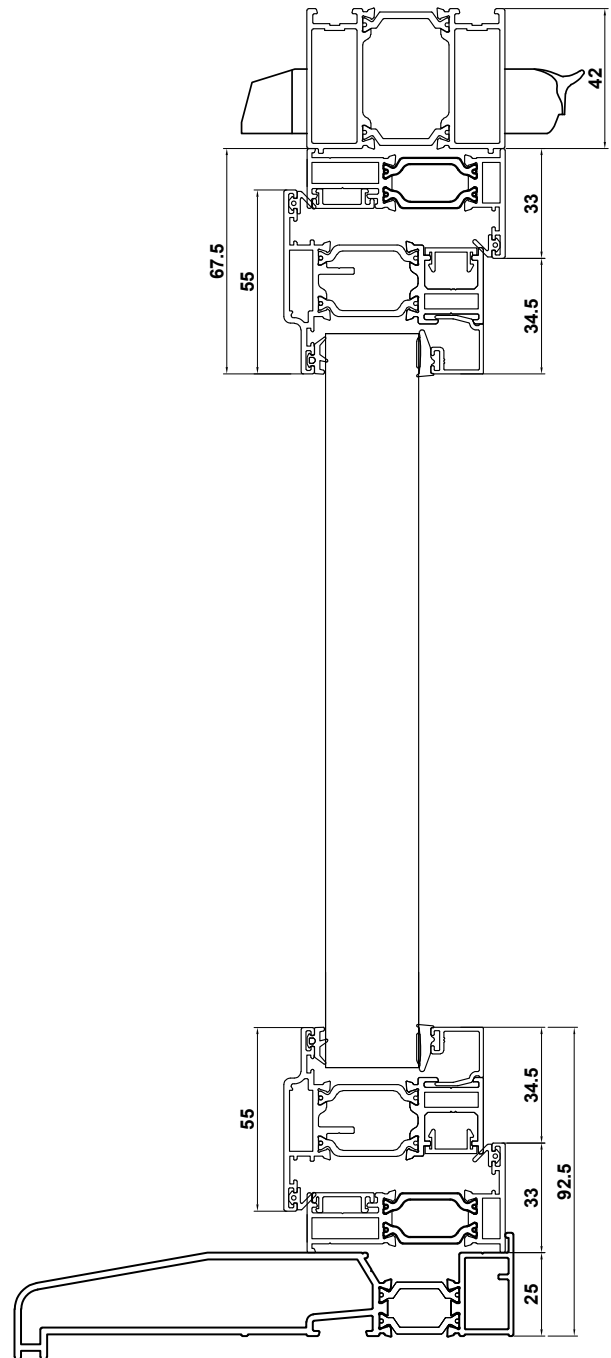
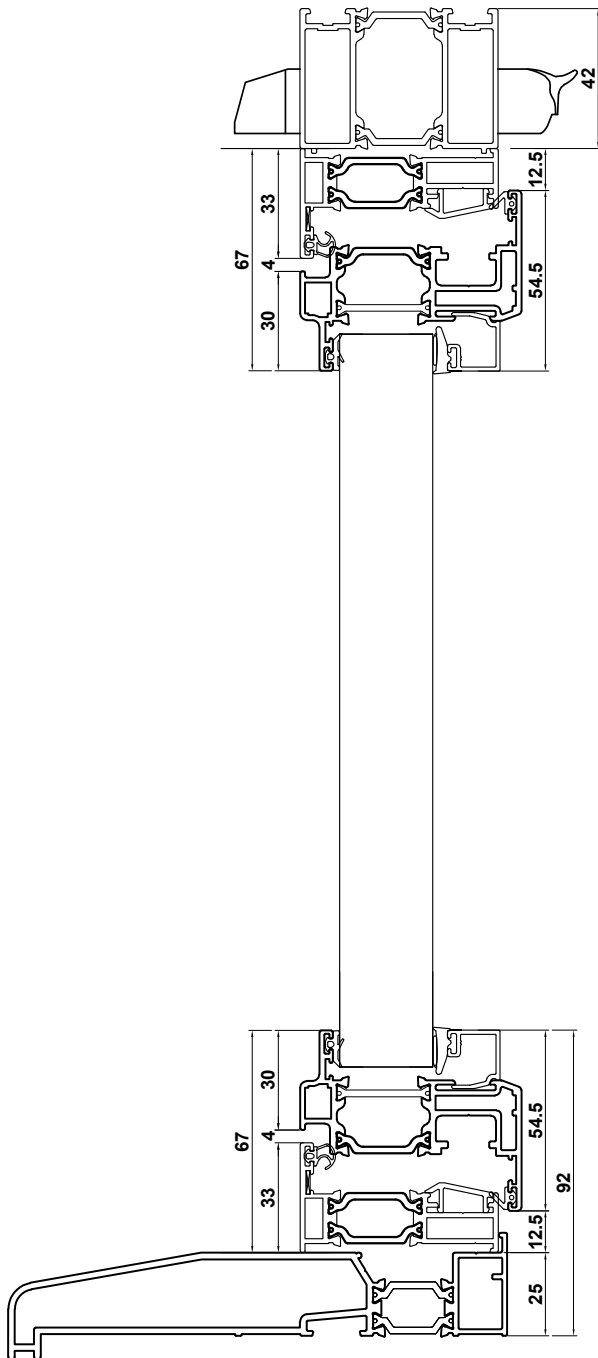

Heritage Doors Assembly Drawings

Heritage 60 Low Threshold

Heritage 60 Open In
W20415 - Outer Frame
W20470 - Low Threshold
EUD03 - Ramps
W20429 - Open In Sash
W20469 - 28mm Glazing Bead

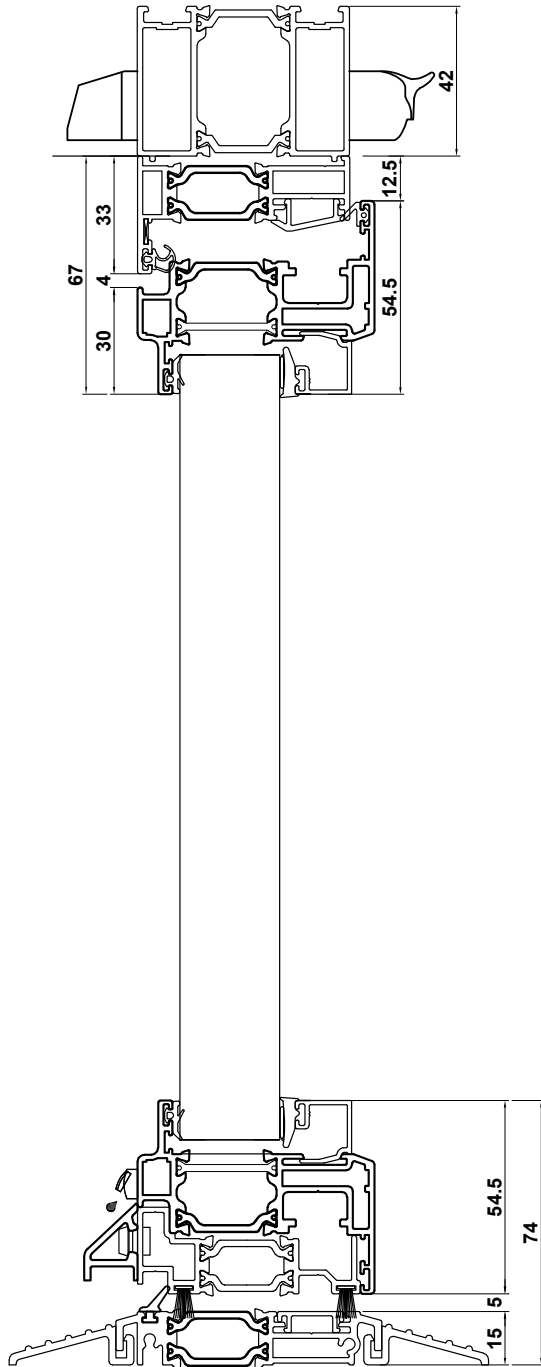

Heritage 60 Open Out
W20415 - Outer Frame
W20470 - Low Threshold
EUD03 - Ramps
W20424 - Open Out Sash
W20469 - 28mm Glazing Bead

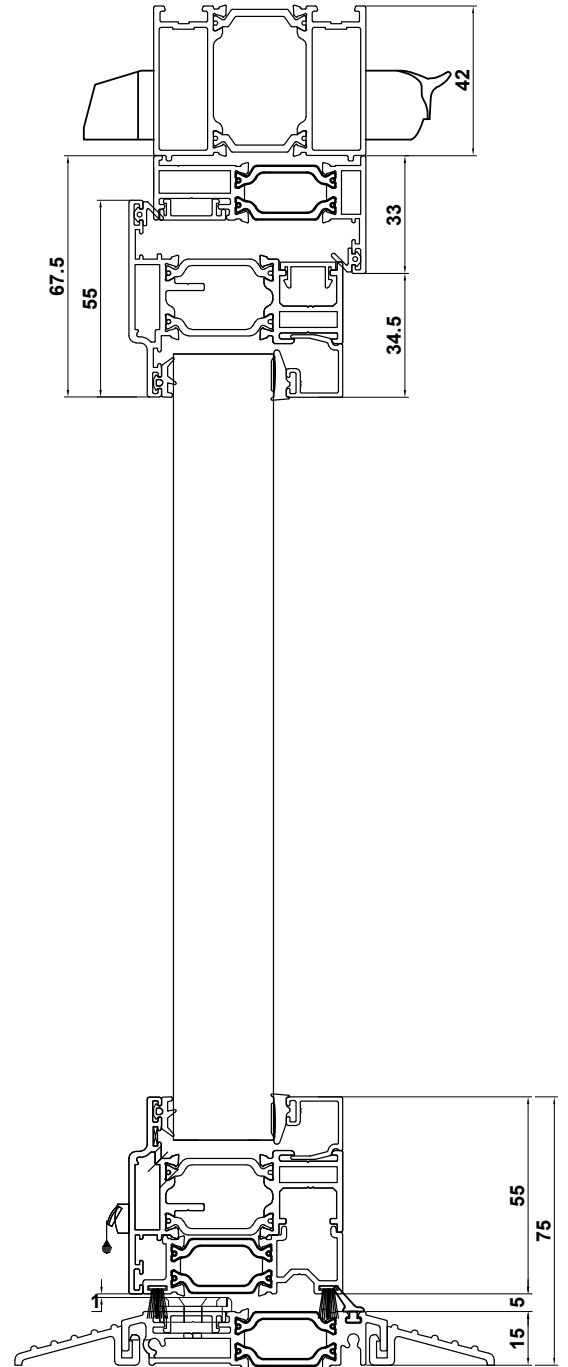

Heritage Doors Main Profile

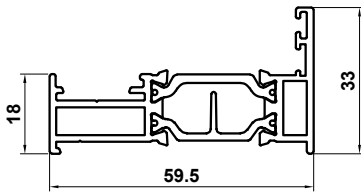

W20415
Outer frame

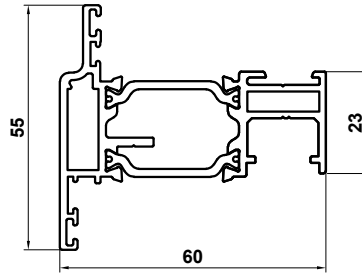

W20424
Door Sash open out

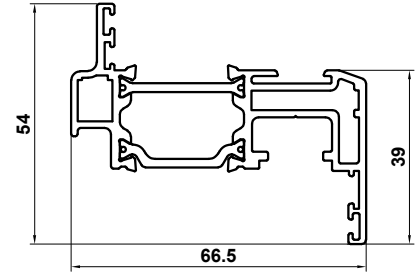

W20429
Door Sash open in

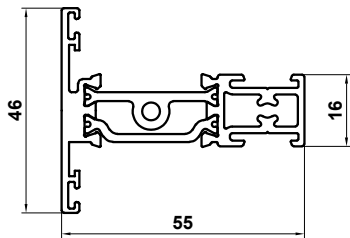

W20430
Transom

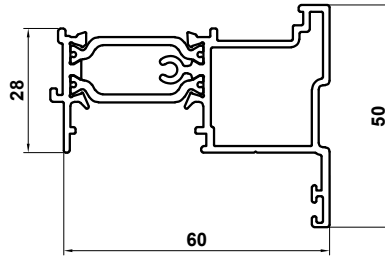

W20446
Flying mullion open out

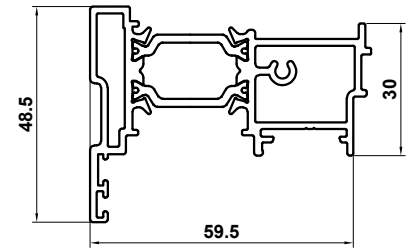

W20449
Flying mullion open in

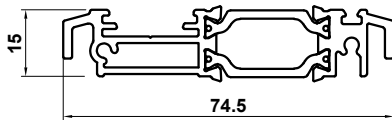

W20470
Low threshold

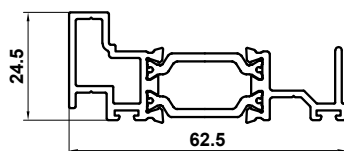

W20474
Low threshold infill open in

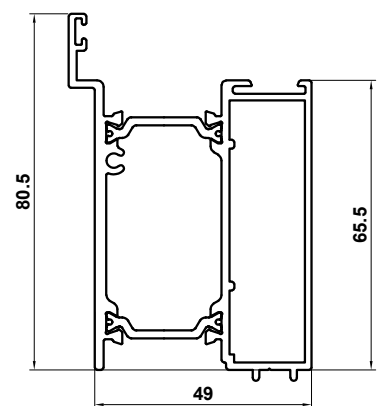

W20438
Lock Box

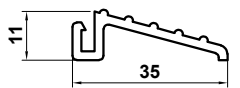

EUD03
Threshold ramp

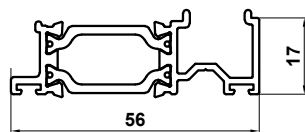

W20472
Low threshold infill open out

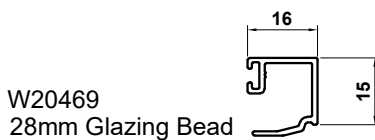

W20469
28mm Glazing Bead

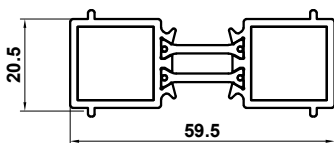

ETC553
20mm coupler

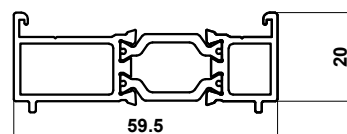

ETC557
20mm Add on

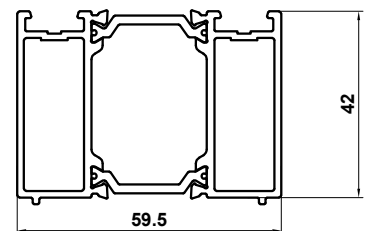

ETC652
42mm Add on

Bi-folding Door Assembly Drawings

New Visofold Slim 1000 Quickglaze Bi-folding Door

Jamb & Mullion Details

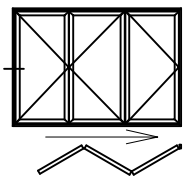

DV14 - Outer Frame
DV220 - Slim Sash
UN3160G - 28mm Glazing

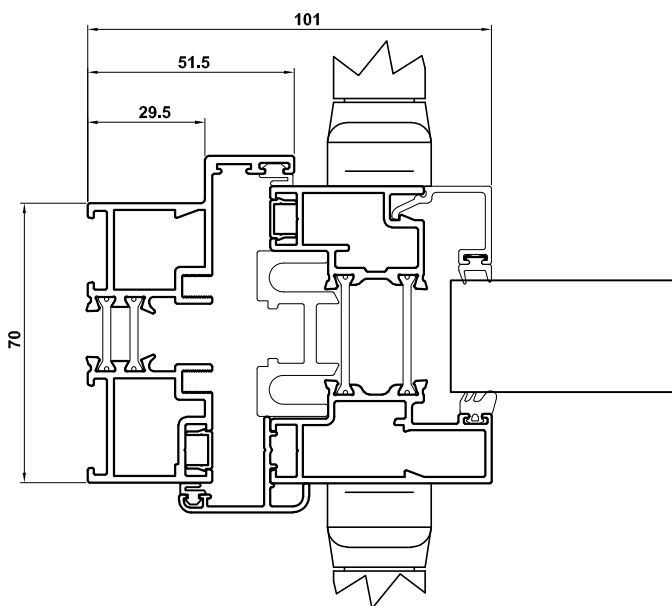

DV14 - Outer Frame
DV220 - Slim Sash
UN3160G - 28mm Glazing

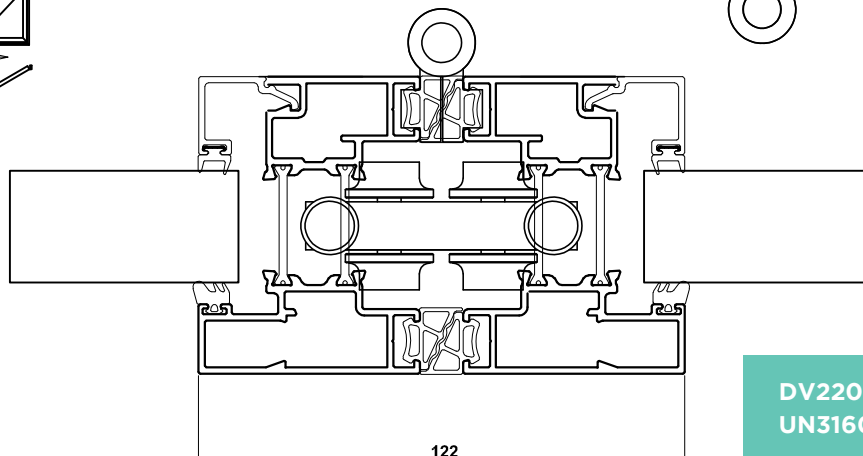
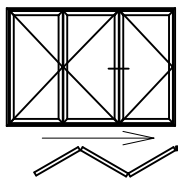
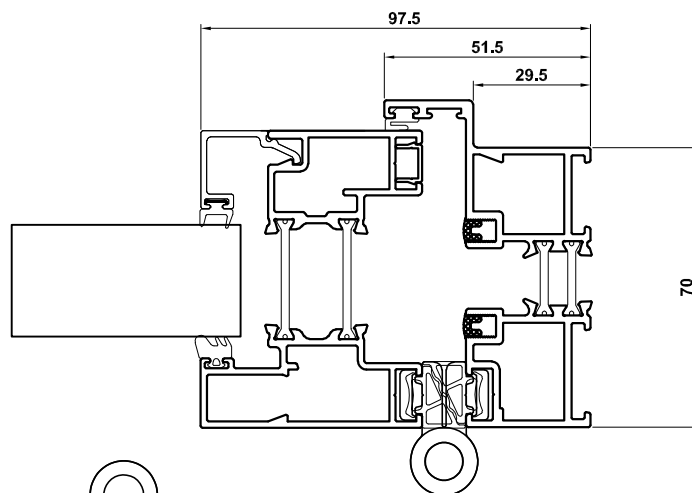
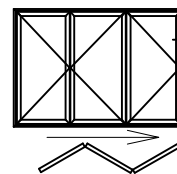

DV220 - Slim Sash
UN3160G - 28mm Glazing

Bi-folding Door Assembly Drawings

New Visofold Slim 1000 Quickglaze Bi-folding Door Head & Threshold Details (Integrated Cill Threshold shown)

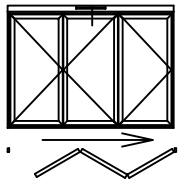

DV14 - Outer Frame
DV220 - Slim Sash
UN3160G - 28mm Glazing
UN3042 - Outer Frame Extension

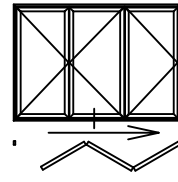

DV14 - Outer Frame
DV220 - Slim Sash
UN3160G - 28mm Glazing

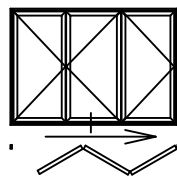
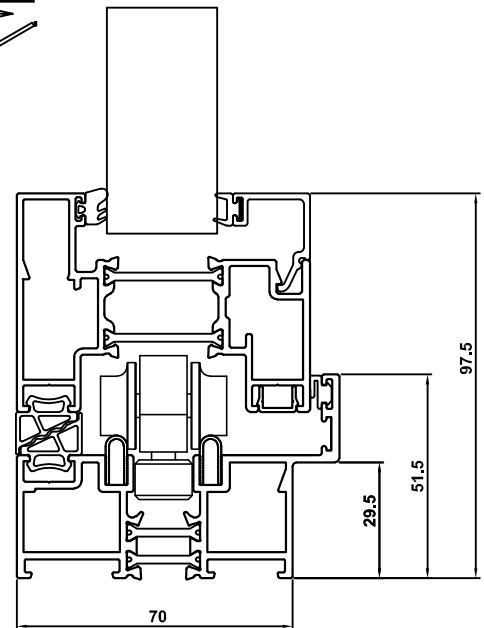
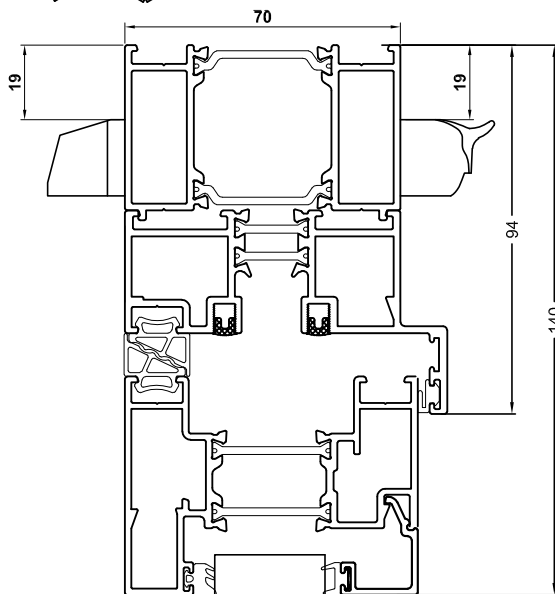

DV176 - Cill Threshold
DV220 - Slim Sash
UN3160G - 28mm Glazing

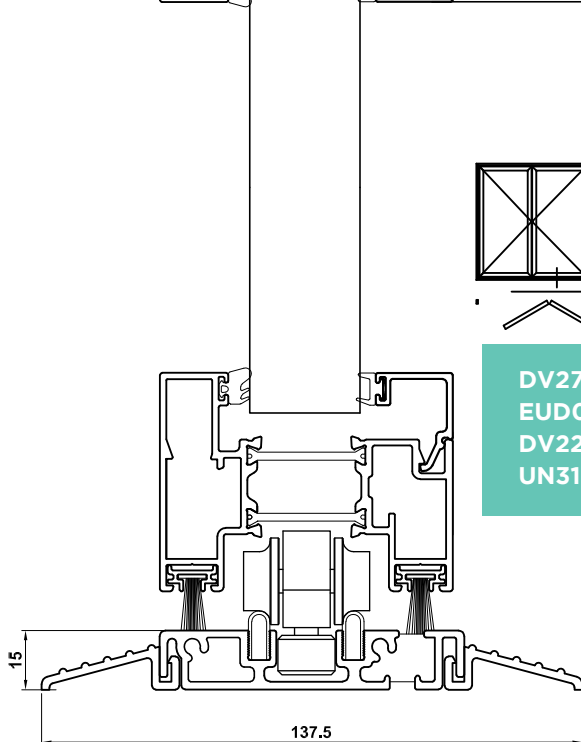

DV271 - Low Threshold, Open Out
EUD03 - Low Threshold Ramp
DV220 - Slim Sash
UN3160G - 28mm Glazing

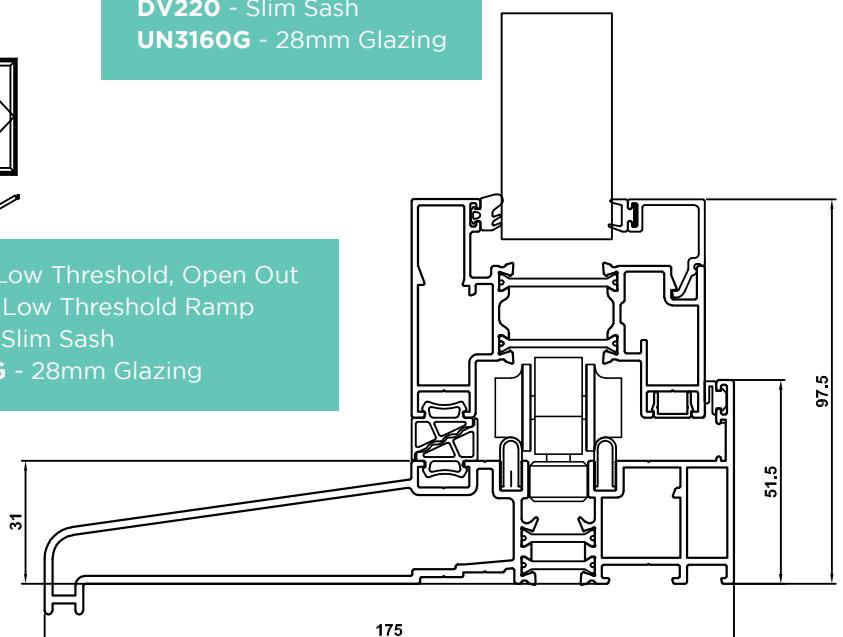

Not weather rated

Bi-folding Door Main Profiles

Visofold SLIM 1000 Quickglaze

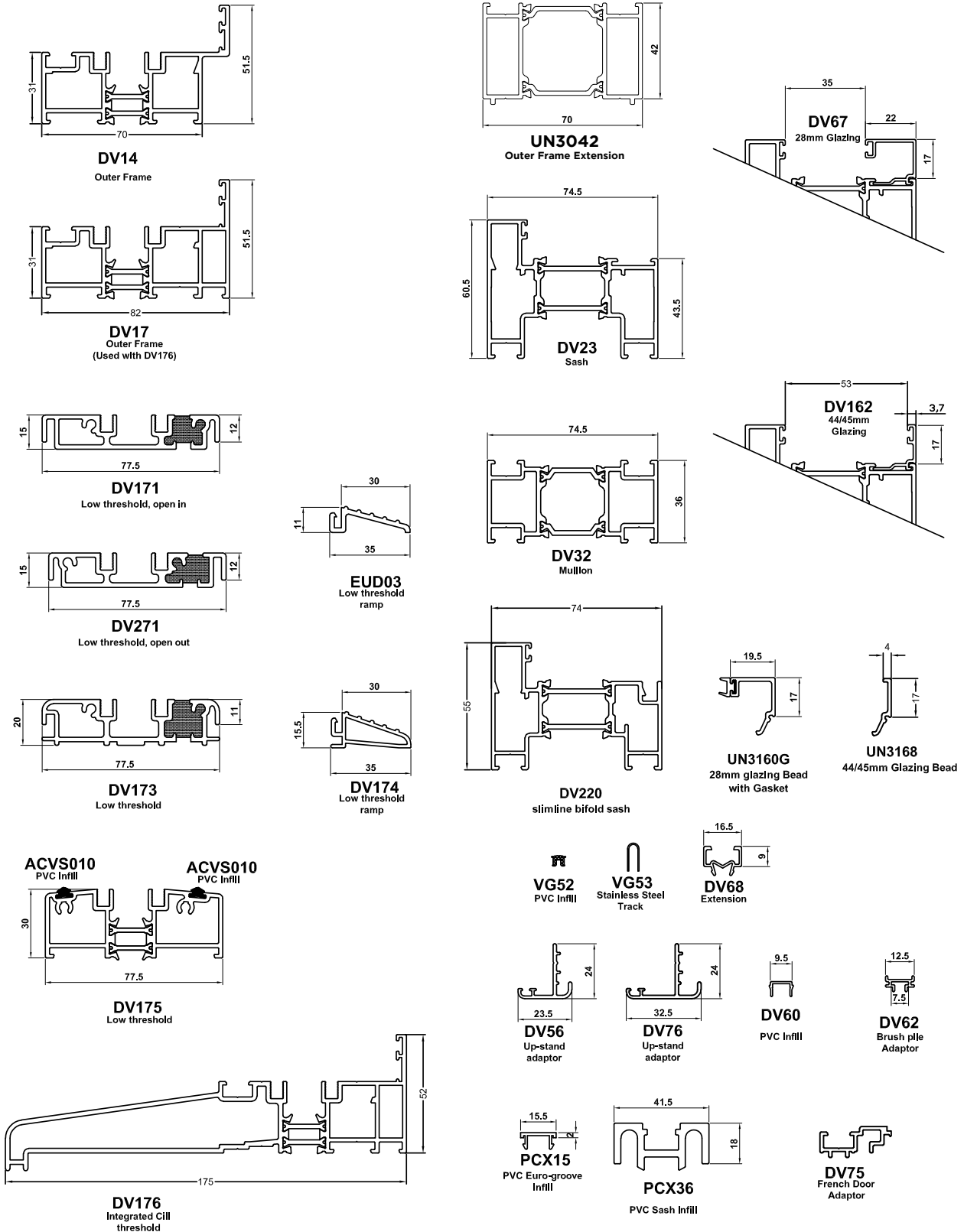

Sliding Door Assembly Drawings

Visoglide Plus (Two Track)

Jamb Details

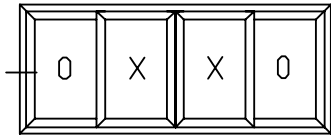

VG510 - Two Track Outer Frame
VG520 - Sash
VG560 - 28mm Glazing Bead

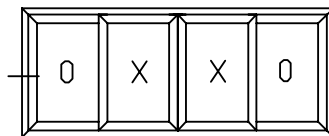
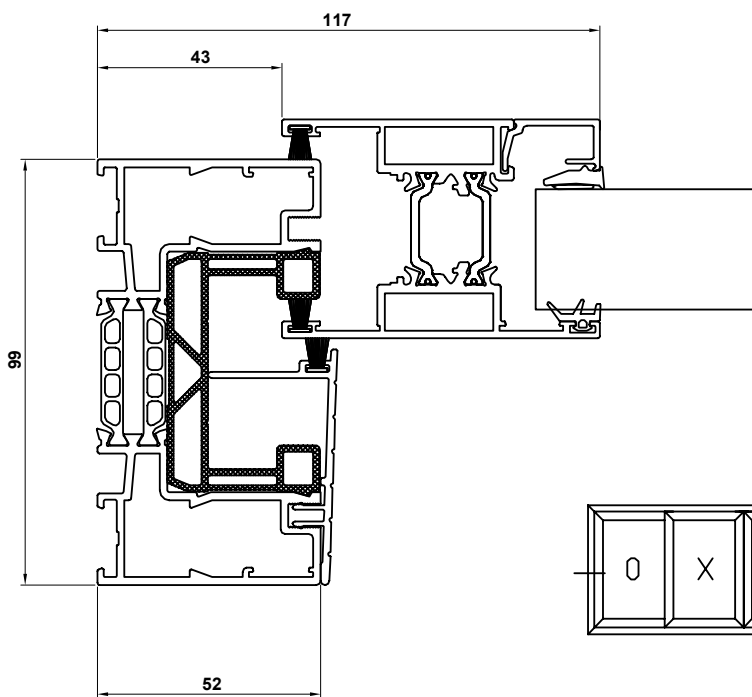

VG511 - Two Track Outer Frame
with Internal Upstand
VG520 - Sash
VG560 - 28mm Glazing Bead

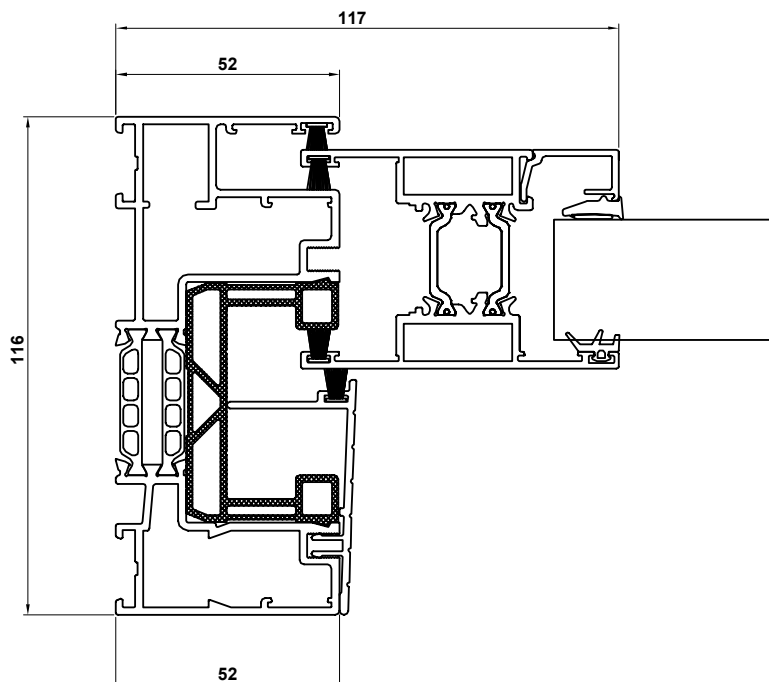

Sliding Door Assembly Drawings

Visoglide Plus (Three Track)

Trickle Vent, Head & Threshold Details – With Standard Frame

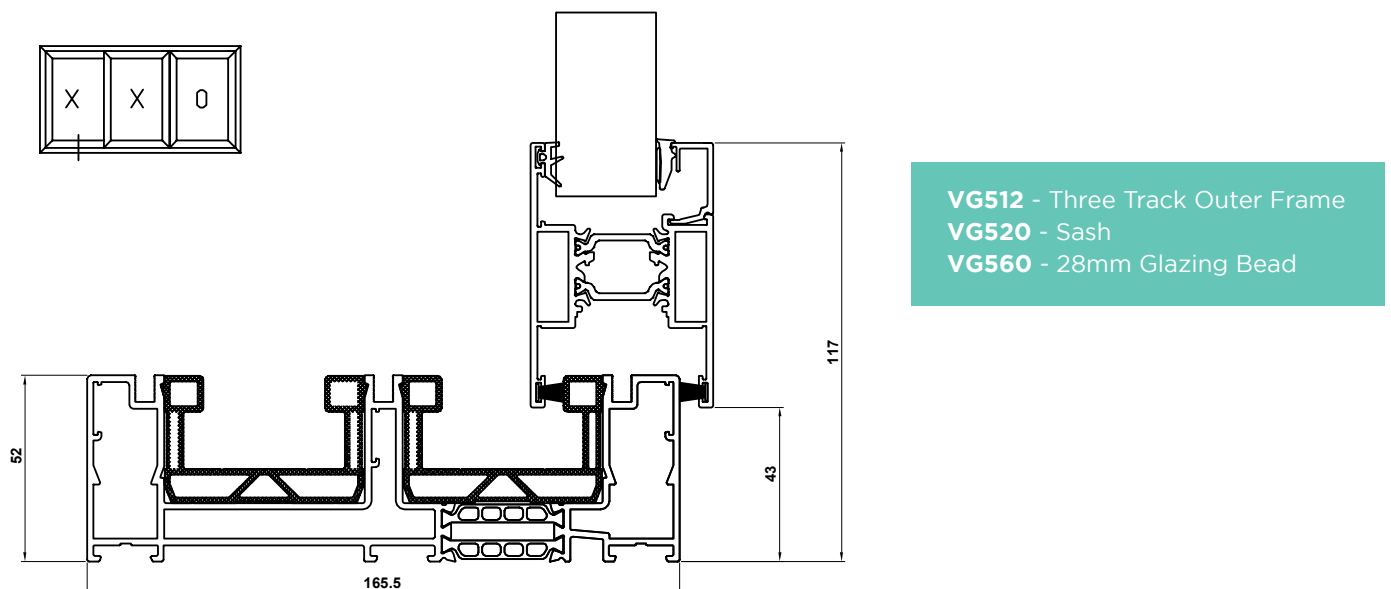
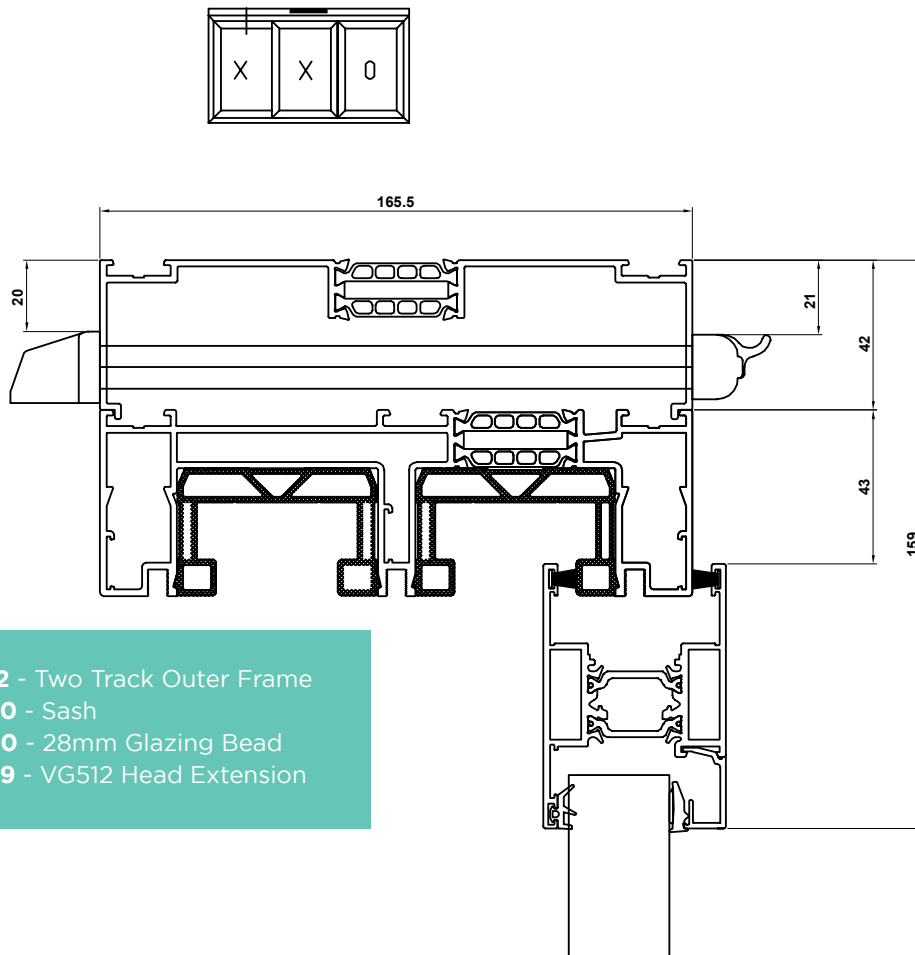

Sliding Door Assembly Drawings

Visoglide Plus (Three Track)

Head & Threshold Details - With Internal Upstand Frame

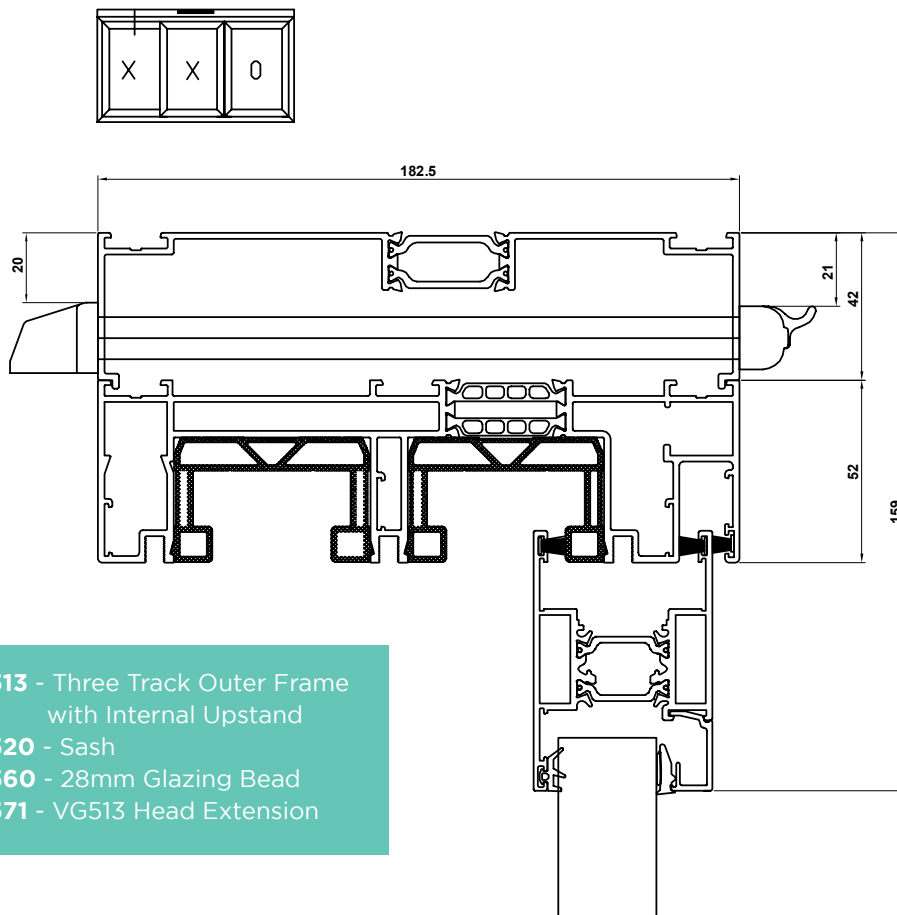

VG513 - Three Track Outer Frame with Internal Upstand
VG520 - Sash
VG560 - 28mm Glazing Bead
VG571 - VG513 Head Extension

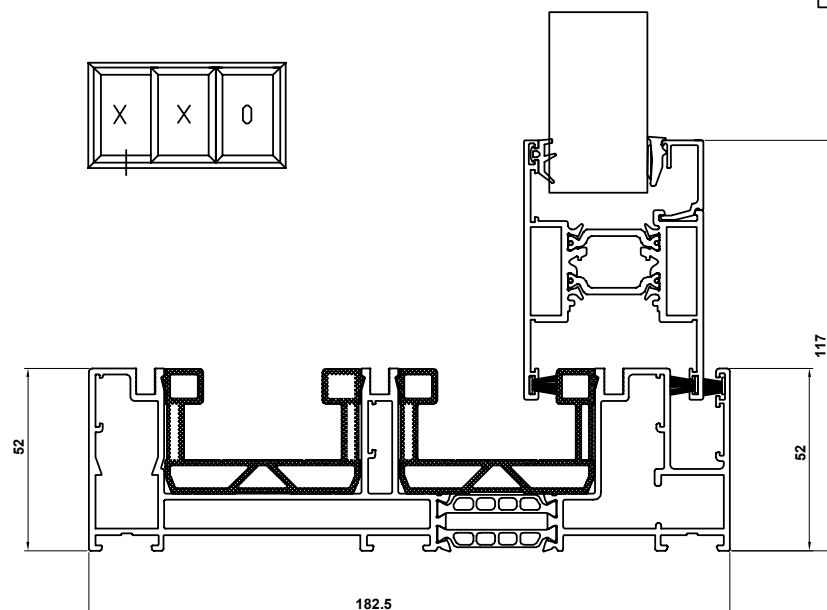

VG513 - Three Track Outer Frame with Internal Upstand
VG520 - Sash
VG560 - 28mm Glazing Bead

Sliding Door Assembly Drawings

Visoglide Plus

Mullion Details

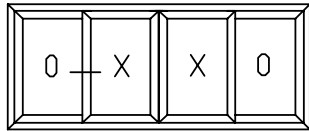

VG520 - Sash
VG551 - PVCu Interlock
VG530 - Interlock Cover
VG560 - 28mm Glazing Bead

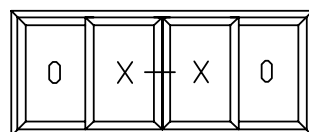
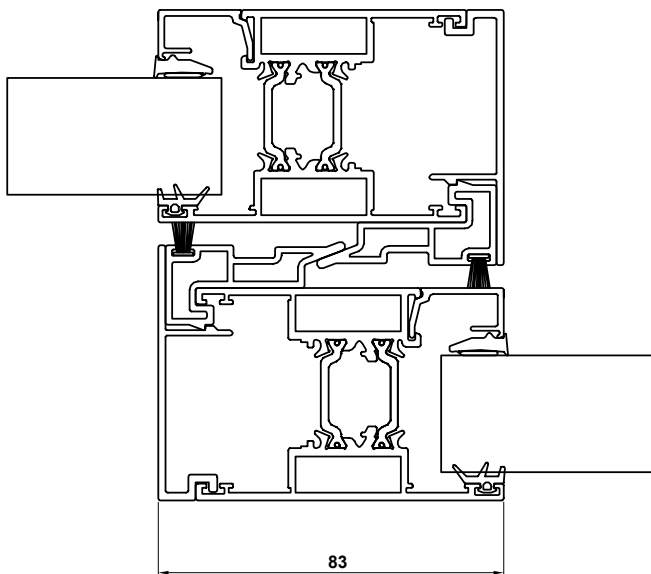

VG520 - Sash
VG540 - Meeting Stile Adaptor
VG560 - 28mm Glazing Bead

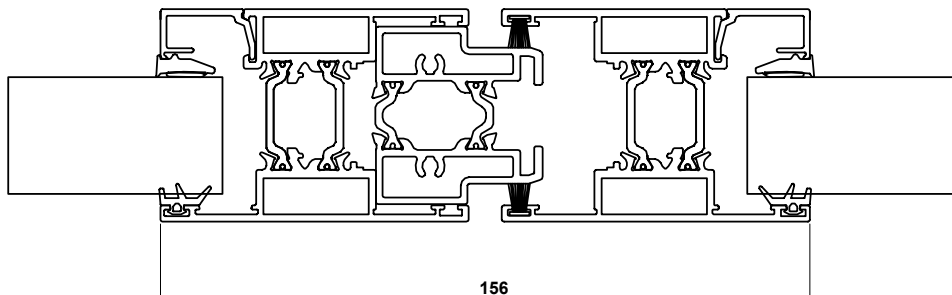

Sliding Door Assembly Drawings

Visoglide Plus

Reinforced Mullion Details

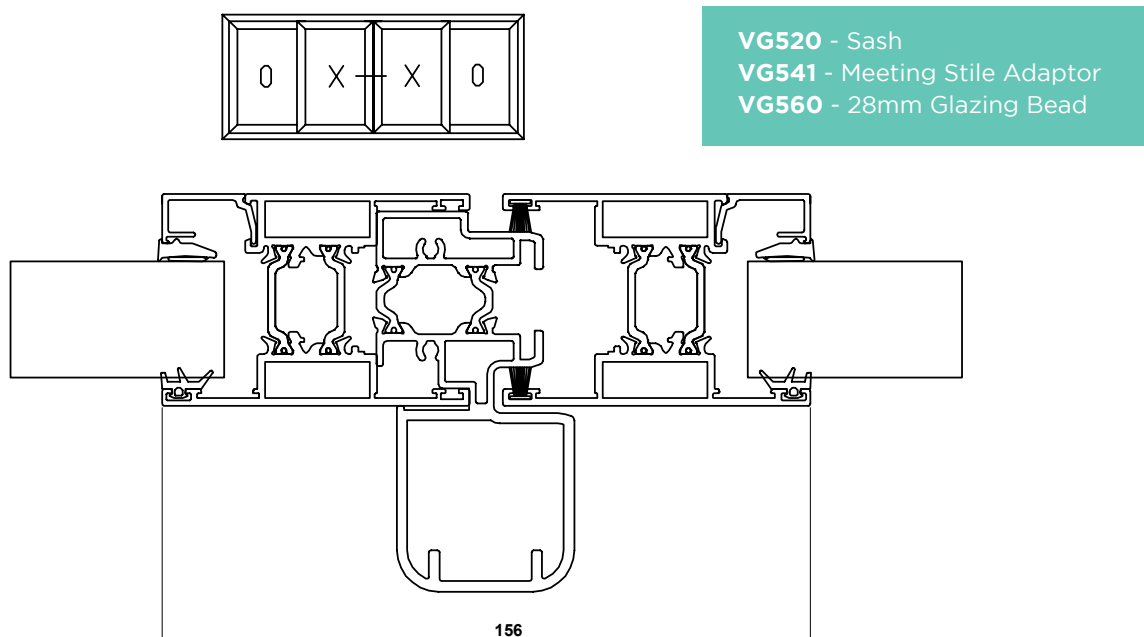
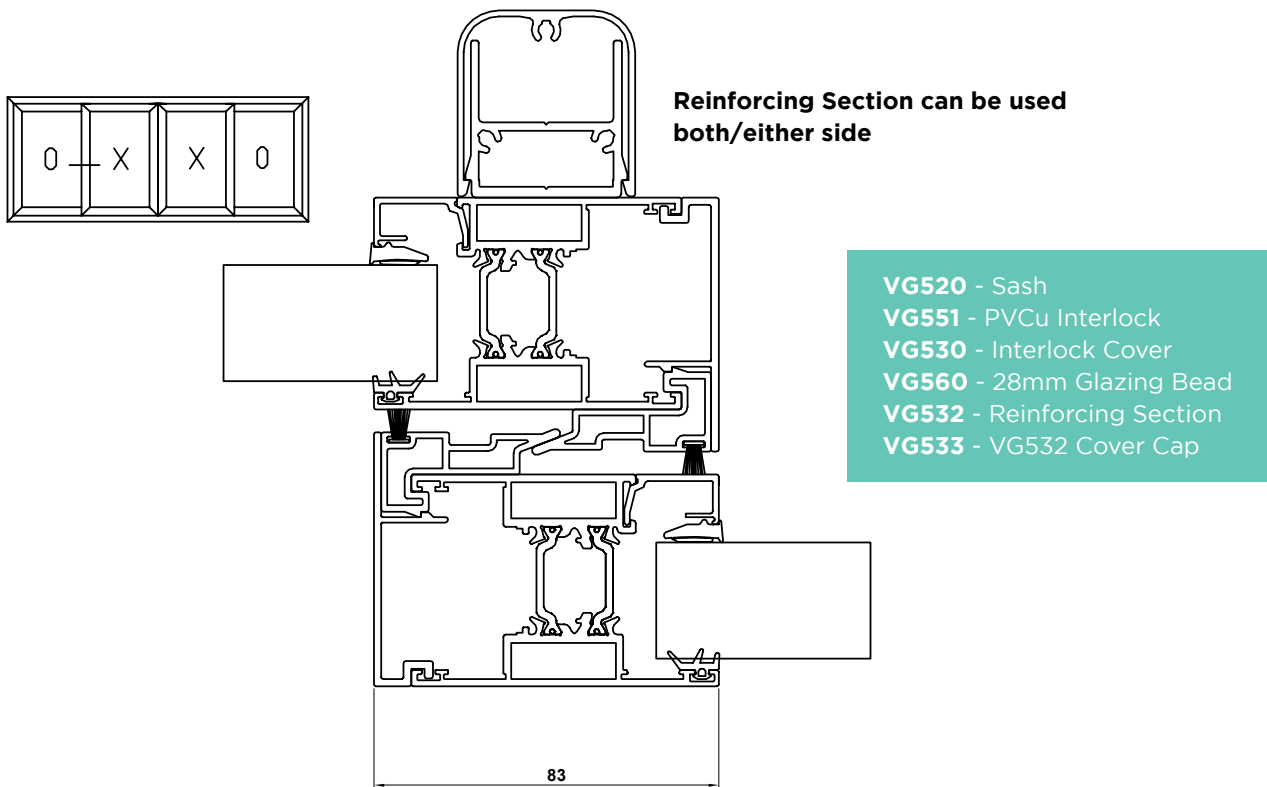

Sliding Door Assembly Drawings

Visoglide Plus

Flush Stacking

Note:

No external handle on flush stacking doors

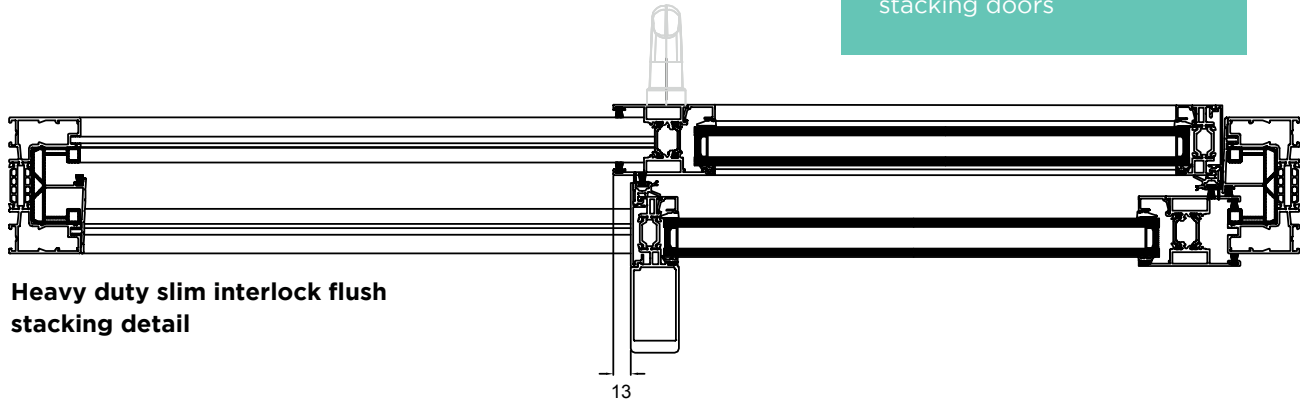

Heavy duty slim interlock flush stacking detail

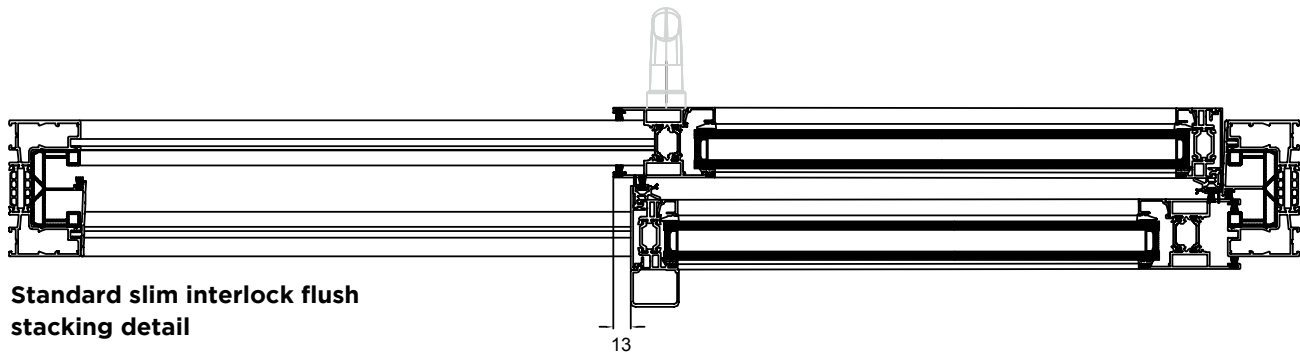

Standard slim interlock flush stacking detail

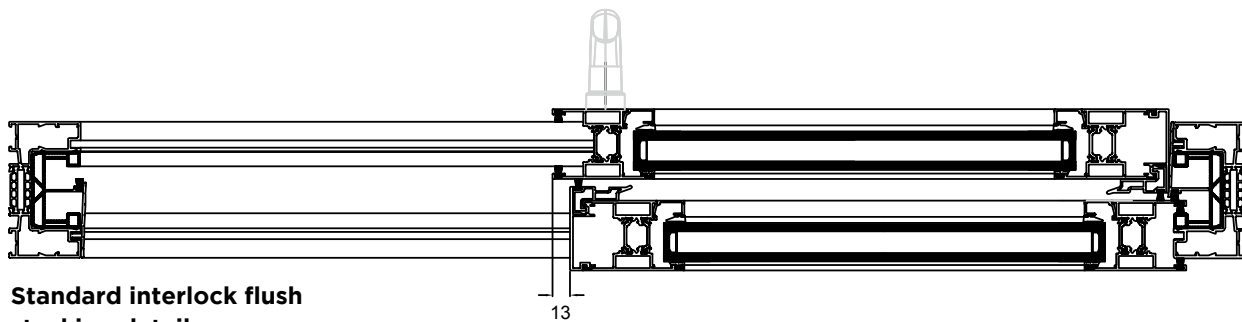

Standard interlock flush stacking detail

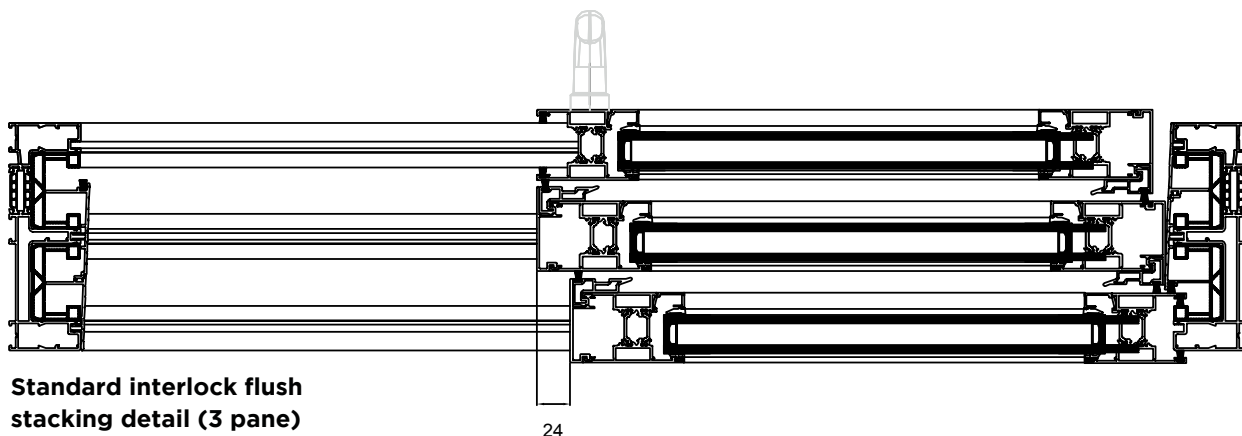

Standard interlock flush stacking detail (3 pane)

Sliding Door Assembly Drawings

Visoglide Plus Slim Interlock Details

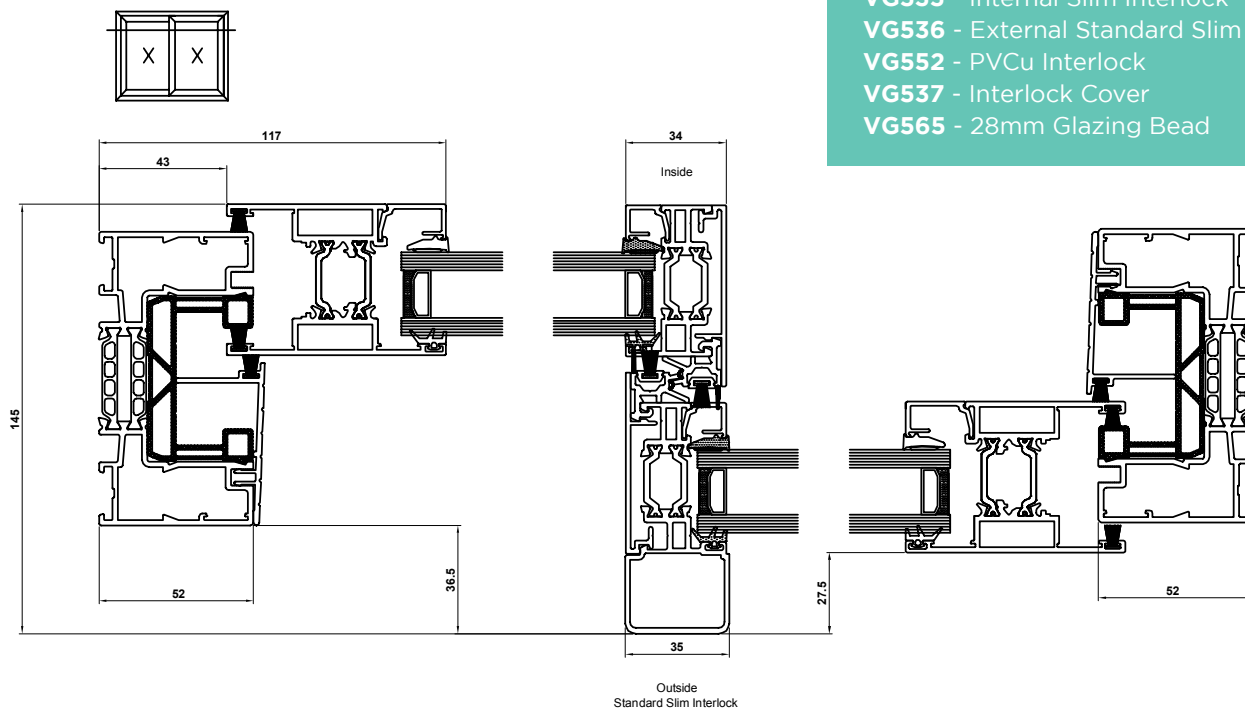

- VG510 - Two Track Outer Frame
- VG520 - Sash
- VG535 - Internal Slim Interlock
- VG536 - External Standard Slim Interlock
- VG552 - PVCu Interlock
- VG537 - Interlock Cover
- VG565 - 28mm Glazing Bead

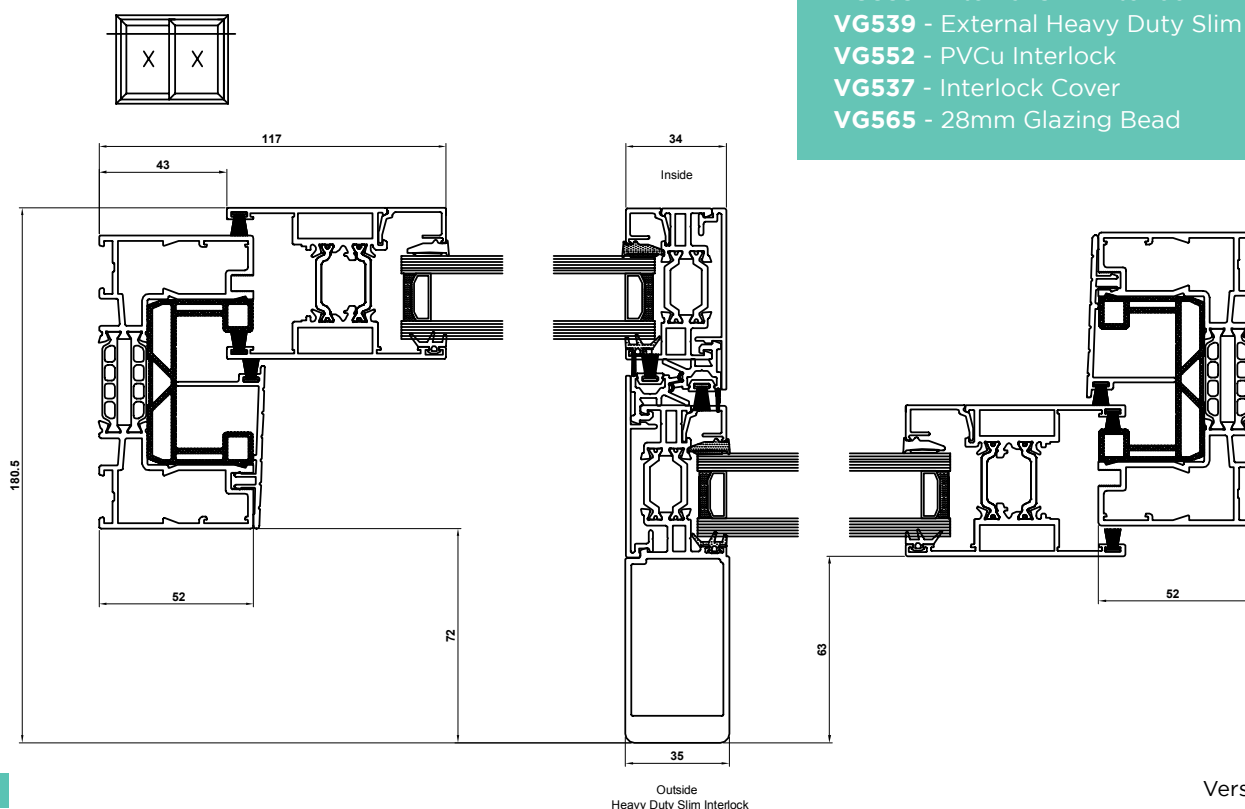

- VG510 - Two Track Outer Frame
- VG520 - Sash
- VG535 - Internal Slim Interlock
- VG539 - External Heavy Duty Slim Interlock
- VG552 - PVCu Interlock
- VG537 - Interlock Cover
- VG565 - 28mm Glazing Bead

Sliding Door Main Profiles

Visoglide Plus

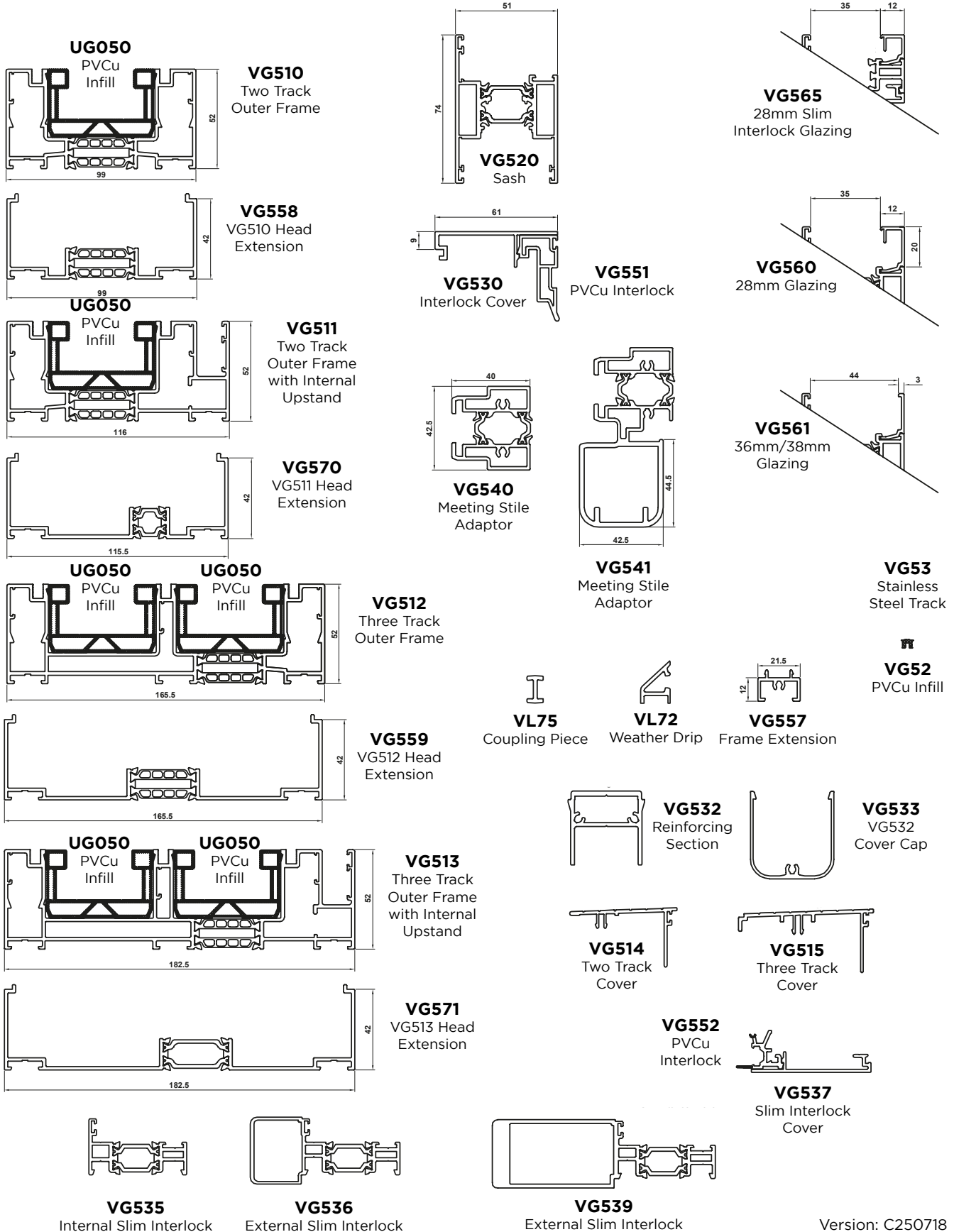

Non-Stock RAL Colour Options

All colours listed here will incur a paint set up charge per colour.

3099ST
9LAANO
AN1003
BS 00A01M
BS 00A05
BS 00A05M
BS 00A05S
BS 00A09
BS 00A13M
BS 00E55M
BS 04C39
BS 04C39M
BS 04E53M
BS 04E53S
BS 08B15
BS 08B15M
BS 08B15S
BS 08B17
BS 08B29
BS 08B29M
BS 08B29S
BS 08C31
BS 08C37
BS 10A01M
BS 10A03M
BS 10A03S
BS 10A05M
BS 10B15
BS 10B15M
BS 10B15S
BS 10B19M
BS 18B25M
BS 288C
BS 381C63
BS 48A09
BS 538
BS 81C628
BS 81C631
BS OA7000
KL001
KL002
KL003
KL004
KL006
KL007
KL009D
KL010
KL011
KL012
KL013
RAL 1000G
RAL 1000M
RAL 1001G
RAL 1001M

RAL 1001S
RAL 1002G
RAL 1002M
RAL 1003G
RAL 1003M
RAL 1004G
RAL 1004M
RAL 1005G
RAL 1005M
RAL 1006G
RAL 1006M
RAL 1007G
RAL 1007M
RAL 1011G
RAL 1011M
RAL 1012G
RAL 1013G
RAL 1013M
RAL 1013S
RAL 1013ST
RAL 1014G
RAL 1014M
RAL 1014S
RAL 1015G
RAL 1015M (KL001)
RAL 1015S
RAL 1015ST
RAL 1016G
RAL 1016M
RAL 1017G
RAL 1017M
RAL 1018G
RAL 1018M
RAL 1019G
RAL 1019M
RAL 1019S
RAL 1020G
RAL 1020M
RAL 1020S
RAL 1021G
RAL 1021M
RAL 1023G
RAL 1023M
RAL 1024G
RAL 1024M
RAL 1027G
RAL 1027M
RAL 1028G
RAL 1028M
RAL 1032G
RAL 1032M
RAL 1033G
RAL 1034G
RAL 1034M

RAL 1035S
RAL 1036M
RAL 1037G
RAL 2000G
RAL 2000M
RAL 2001G
RAL 2002G
RAL 2002M
RAL 2002S
RAL 2003G
RAL 2004G
RAL 2004M
RAL 2008G
RAL 2008M
RAL 2009G
RAL 2009M
RAL 2010G
RAL 2010M
RAL 2011G
RAL 2011M
RAL 2012G
RAL 2013M
RAL 2236M
RAL 3000G
RAL 3000M
RAL 3001G
RAL 3001M
RAL 3002G
RAL 3002M
RAL 3003G
RAL 3003M
RAL 3003S
RAL 3004G
RAL 3004M (KL002)
RAL 3004S
RAL 3005G
RAL 3005M
RAL 3005ST
RAL 3007M
RAL 3009M
RAL 3009S
RAL 3009ST
RAL 3011G
RAL 3012G
RAL 3012M
RAL 3013G
RAL 3013M
RAL 3014G
RAL 3014M
RAL 3015G
RAL 3015M
RAL 3016G
RAL 3016M
RAL 3017G

RAL 3017M
RAL 3018G
RAL 3018M
RAL 3020G
RAL 3020M
RAL 3020S
RAL 3022G
RAL 3022M
RAL 3031S
RAL 4002G
RAL 4003G
RAL 4005G
RAL 4005M
RAL 4008G
RAL 4009G
RAL 5000G
RAL 5000M
RAL 5001G
RAL 5001M
RAL 5001S
RAL 5002G
RAL 5002M
RAL 5002S
RAL 5003G
RAL 5003M
RAL 5003S
RAL 5004G
RAL 5004M
RAL 5005G
RAL 5005M
RAL 5005S
RAL 5007G
RAL 5007M
RAL 5008G
RAL 5008M
RAL 5008S
RAL 5009G
RAL 5009M
RAL 5009S
RAL 5010G
RAL 5010M
RAL 5010S
RAL 5011G
RAL 5011M (KL003)
RAL 5011S
RAL 5011ST
RAL 5012G
RAL 5012M
RAL 5012S
RAL 5013G
RAL 5013M
RAL 5013S
RAL 5014G
RAL 5014M

Price on application for any colours/finishes not listed.

Note: Non-stock RAL colours are available on REAL Aluminium **standard** aluminium lead times.

Non-Stock RAL Colour Options

All colours listed here will incur a paint set up charge per colour.

RAL 5014S
RAL 5015G
RAL 5015M
RAL 5015S
RAL 5017G
RAL 5017M
RAL 5017S
RAL 5018G
RAL 5018M
RAL 5019G
RAL 5019M
RAL 5019S
RAL 5020G
RAL 5020M
RAL 5020S
RAL 5021G
RAL 5021M
RAL 5021S
RAL 5022G
RAL 5022M
RAL 5022S
RAL 5023G
RAL 5023M
RAL 5024G
RAL 5024M
RAL 5024S
RAL 5111ST
RAL 6000G
RAL 6000M
RAL 6001G
RAL 6001M
RAL 6001S
RAL 6002G
RAL 6002M
RAL 6002S
RAL 6003G
RAL 6003M
RAL 6003S
RAL 6004G
RAL 6005G
RAL 6005M
RAL 6005S
RAL 6006G
RAL 6006M
RAL 6006S
RAL 6007G
RAL 6007M
RAL 6008G
RAL 6009G
RAL 6009M (KL004)
RAL 6009S
RAL 6009ST
RAL 6010G
RAL 6010M

RAL 7000G
RAL 7000M
RAL 7000S
RAL 6011G
RAL 6011M
RAL 6011S
RAL 6012G
RAL 6012M
RAL 6013G
RAL 6013M
RAL 6013S
RAL 6014G
RAL 6014M
RAL 6015G
RAL 6015M
RAL 6015S
RAL 6016G
RAL 6016M
RAL 6016S
RAL 6017G
RAL 6017M
RAL 6018G
RAL 6018M
RAL 6019G
RAL 6019M
RAL 6019S
RAL 6020G
RAL 6020M
RAL 6021G
RAL 6021M
RAL 6021S
RAL 6022G
RAL 6022M
RAL 6024G
RAL 6024M
RAL 6025G
RAL 6026G
RAL 6026M
RAL 6026S
RAL 6027G
RAL 6027M
RAL 6028G
RAL 6028M
RAL 6029G
RAL 6029M
RAL 6032G
RAL 6032M
RAL 6033G
RAL 6033M
RAL 6034G
RAL 6034M
RAL 6034S
RAL 6099ST
RAL 6999ST

RAL 7000ST
RAL 7001G
RAL 7001M
RAL 7001S
RAL 7002G
RAL 7002M
RAL 7002S
RAL 7003G
RAL 7003M
RAL 7003S
RAL 7004G
RAL 7004M
RAL 7004S
RAL 7005G
RAL 7005M
RAL 7005S
RAL 7006G
RAL 7006M
RAL 7006S
RAL 7009G
RAL 7009M
RAL 7010G
RAL 7010M
RAL 7010S
RAL 7011G
RAL 7011M
RAL 7011S
RAL 7012G
RAL 7012M
RAL 7012S
RAL 7013G
RAL 7013M
RAL 7015G
RAL 7015M
RAL 7015S
RAL 7016G
RAL 7016S
RAL 7016ST
RAL 7021G
RAL 7021M
RAL 7021S
RAL 7021ST
RAL 7022G
RAL 7022M
RAL 7022S
RAL 7023G
RAL 7023M
RAL 7023S
RAL 7024G
RAL 7024M
RAL 7024S
RAL 7026G
RAL 7026M
RAL 7026S

RAL 7030G
RAL 7030M
RAL 7030S
RAL 7031G
RAL 7031M
RAL 7031S
RAL 7032G
RAL 7032M
RAL 7032S
RAL 7033G
RAL 7033M
RAL 7033S
RAL 7034G
RAL 7034M
RAL 7034S
RAL 7034ST
RAL 7035G
RAL 7035M
RAL 7035S
RAL 7036G
RAL 7036M
RAL 7036S
RAL 7037G
RAL 7037M
RAL 7037S
RAL 7038G
RAL 7038M
RAL 7038S
RAL 7039G
RAL 7039M
RAL 7039S
RAL 7040G
RAL 7040M
RAL 7040S
RAL 7040ST
RAL 7042G
RAL 7042M
RAL 7042S
RAL 7043G
RAL 7043M
RAL 7043S
RAL 7044G
RAL 7044M
RAL 7044S
RAL 7045G
RAL 7045M
RAL 7045S
RAL 7046G
RAL 7046M
RAL 7046S
RAL 7047G
RAL 7047M
RAL 7047S
RAL 8000G

Price on application for any colours/finishes not listed.

Note: Non-stock RAL colours are available on REAL Aluminium **standard** aluminium lead times.

Non-Stock RAL Colour Options

All colours listed here will incur a paint set up charge per colour.

RAL 8001G
RAL 8001M
RAL 8001S
RAL 8002G
RAL 8002M
RAL 8003G
RAL 8003M
RAL 8003S
RAL 8004G
RAL 8004M
RAL 8004S
RAL 8007G
RAL 8007M
RAL 8008G
RAL 8008M
RAL 8009ST
RAL 8011G
RAL 8011M
RAL 8011S
RAL 8012G
RAL 8012M
RAL 8012S
RAL 8014G
RAL 8014M (KL006)
RAL 8014S
RAL 8014ST
RAL 8015G
RAL 8015M
RAL 8015S
RAL 8016G
RAL 8016M
RAL 8016S
RAL 8017G
RAL 8017M
RAL 8017S
RAL 8019G (KL007)
RAL 8019M
RAL 8019S
RAL 8019ST
RAL 8022G
RAL 8022M
RAL 8022S
RAL 8023G
RAL 8023M
RAL 8023S
RAL 8024G
RAL 8024M
RAL 8024S
RAL 8025G
RAL 8025M
RAL 8028G
RAL 8028M
RAL 8028S
RAL 8029G

RAL 8029M
RAL 8040G
RAL 8040M
RAL 8040S
RAL 8070G
RAL 8070M
RAL 8070S
RAL 8080M
RAL 8080S
RAL 8912G
RAL 8912S
RAL 9001G
RAL 9001M
RAL 9001S (KL011)
RAL 9001ST
RAL 9002G
RAL 9002M
RAL 9002S
RAL 9003G
RAL 9003M
RAL 9003S
RAL 9004G
RAL 9004M
RAL 9004S
RAL 9005S
RAL 9005ST
RAL 9006G
RAL 9006S
RAL 9006ST
RAL 9007G
RAL 9007ST
RAL 9008ST
RAL 9009ST
RAL 9010G
RAL 9010M (KL010)
RAL 9010S
RAL 9010ST
RAL 9011G
RAL 9011M
RAL 9011S
RAL 9016G
RAL 9016M
RAL 9016S
RAL 9016ST
RAL 9017G
RAL 9017M
RAL 9017S
RAL 9018G
RAL 9018M
RAL 9018S
RAL 9021S
RAL 9910G
RAL 9910M
RAL 9910S

RAL 9911M
SA
SEN001
SEN002
SEN003
SEN004
SEN005
SEN006
SEN007
SEN009
SEN010
SEN011
SEN012
SEN013
SEN014
SEN015
SEN016
SEN017
SEN018
SEN020
SEN022
SEN024
SEN025
SEN026
SEN028
SEN031
SM286G

RAL
KL
Sensations
M = Matt
S = Satin
ST = Stippolyte/Texture
G = Gloss

Stock Colour Options

RAL 7016M (KL005) - Anthracite Grey (Matt)
RAL 9005M (KL008) - Black (Matt)
KL009 - White (Gloss)
RAL 7016M (KL005) on White (Gloss) (KL009)

Price on application for any colours/finishes not listed.

Note: Non-stock RAL colours are available on REAL Aluminium **standard** aluminium lead times.

Part L and Part F Building Regulations

In the shift towards a Future Buildings Standard, the government has introduced a range of changes to the Building Regulations, including a mandatory 30 per cent cut in carbon for all new homes and a 27 per cent cut for other buildings, including offices and shops[†].

With the impact of climate change and the increase in urbanisation, we now not only need to ensure the homes of the UK are warm, energy efficient and provide exceptional thermal performance, but that they are also well ventilated for cleaner, cooler air.

Changes to Part L and Part F of the Building Regulations in England were introduced on the 15th June 2022, to ensure all new and renovation projects are on-spec for thermal efficiency, energy efficiency and ventilation capability.



What this means to you, the Installer

The information we have provided within this document will help you understand what is required to be compliant with the new Regulations.

Approved Document L and Approved Document F will outline the criteria required for domestic, non-domestic, new-build and renovation project buildings. Part L focuses on the energy efficiency levels and the thermal performance of the building, set to reduce the impact on fuel usage, whilst Part F focuses on the ventilation performance, which can be as simple as how many windows can open within a property, to minimising the ingress of external pollutants and the proper installation of ventilation systems. Therefore, when installing windows and doors, you will need to ensure they are approved to the new specifications.

Our products and systems are obviously key to the compliance of these new Regulations, so if you have any queries regarding design, our products, or even the Regulations themselves, our Customer Services, Sales or Technical Teams are always here to help and support you.

What we've done to meet the new Regulations

Conserving energy (PART L)

At REAL, we are proud to be a responsible manufacturer. That means we take changes in Regulations seriously – to ensure we're compliant, you're compliant and your customers enjoy products that meet the current standards. Our aluminium profiles are manufactured using the highest quality materials but it's important to understand how glazing can make a significant difference to how the completed window performs.

It's also worth noting that the new Part L Regulations for New Build properties focus on 'U' values, whilst Renovation Properties will be assessed on Energy Ratings or 'U' Values.

Our completed windows have achieved an 'A' Rating and 'U' Values that meet the standards. We have created the following tables to help you identify what's required to ensure your completed product is compliant.

Replacement on Existing Dwellings or Extensions

(Energy Ratings)

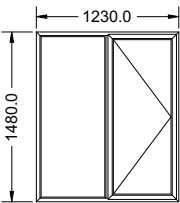
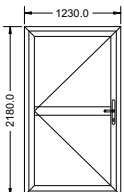
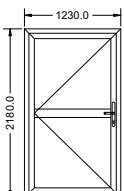
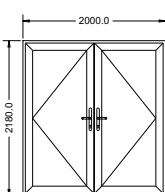
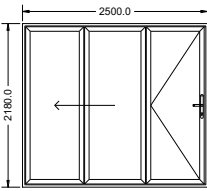
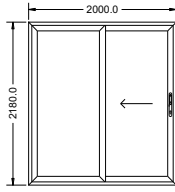
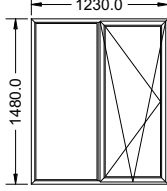
REQUIREMENT	WINDOW/DOOR DESIGN	SYSTEM	DOUBLE GLAZED UNIT SPEC	ACTUAL RATING
B rated or Uw 1.4 W/m ² k		NEW PRODUCT Alitherm 400 Window (F)	28mm unit clear/argon/softcoat 1.2 Centre pane 1.22 W/m ² k warm edge spacer	A
		Alitherm Heritage 47	28mm unit clear/argon/softcoat 1.2 Centre pane 1.22 W/m ² k warm edge spacer	B
>60% glazed door C rated or Ud 1.4 W/m ² k		NEW PRODUCT Alitherm Heritage 60	Double glazed 28mm unit clear/argon/softcoat 1 Centre pane 1.068W/m ² k Warm edge spacer	C
>60% glazed door Ud 1.6 W/m ² k minimum Ud 1.2 W/m ² k Target		NEW PRODUCT Heritage 60	36mm unit clear/softcoat /softcoat 1 Centre pane 0.7 W/m ² k Warm edge spacer	
C rated or Ud 1.4 W/m ² k		NEW PRODUCT Alitherm 400 French Door (F)	28mm unit clear/argon/softcoat 1.2 Centre pane 1.22 W/m ² k warm edge spacer	C
C rated or Ud 1.4 W/m ² k		Visofold SLIM 1000 Bi-fold door	28mm unit clear/argon/softcoat 1.2 Centre pane 1.22 W/m ² k warm edge spacer	C
C rated or Ud 1.4 W/m ² k		Visoglide Plus Sliding Door	28mm unit clear/argon/softcoat 1.2 Centre pane 1.22 W/m ² k warm edge spacer	B
B rated or Uw 1.4 W/m ² k		Alitherm 400 TBT	28mm unit clear/argon/softcoat 1.2 Centre pane 1.22 W/m ² k warm edge spacer	B

Band B achievable
with low iron glass

Band B achievable
with low iron glass

Glass type 1.2 -examples K glass S, Planitherm Total, Climaguard A+

Extensions U Values

(Limiting U Value 1.4 W/m²k)

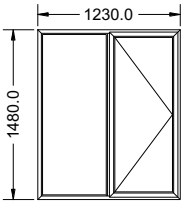
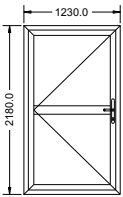
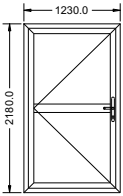
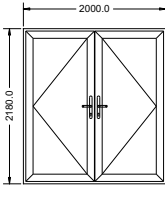
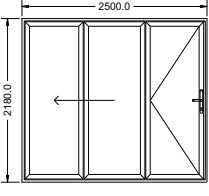
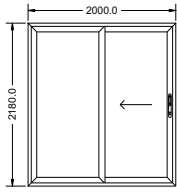
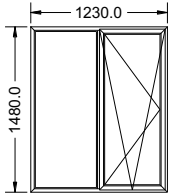
REQUIREMENT	WINDOW/DOOR DESIGN	SYSTEM	GLAZED UNIT SPEC	ACTUAL UW/UD
B rated or Uw 1.4W/m ² k		NEW PRODUCT Alitherm 400 Window (F)	Double glazed 28mm unit clear/argon/softcoat 1 Centre pane 1.068 W/m ² k warm edge spacer	1.3 W/m ² K
		Alitherm Heritage 47	28mm unit clear/argon/softcoat 1.2 Centre pane 1.22 W/m ² k warm edge spacer	
>60% glazed door C rated or Ud 1.4W/m ² k		NEW PRODUCT Alitherm Heritage 60	Double glazed 28mm unit clear/argon/softcoat 1 Centre pane 1.068W/m ² k warm edge spacer	1.3 W/m ² K
>60% glazed door Ud 1.6 W/m ² k minimum Ud 1.2 W/m ² k Target		NEW PRODUCT Heritage 60	36mm unit clear/softcoat /softcoat 1 Centre pane 0.7 W/m ² k Warm edge spacer	1.2 W/m ² K
C rated or Ud 1.4W/m ² k		NEW PRODUCT Alitherm 400 French Door (F)	Double glazed 28mm unit clear/argon/softcoat 1 Centre pane 1.07W/m ² k warm edge spacer	1.4 W/m ² K
C rated or Ud 1.4W/m ² k		Visofold Slim 1000 Bi-fold door	Triple glazed 44mm unit clear/softcoat 1.2/softcoat 1.2 Centre pane 0.65 W/m ² k warm edge spacer	1.2 W/m ² K
C rated or Ud 1.4W/m ² k		Visoglide Plus Sliding Door (F)	Double glazed 28mm unit clear/argon/softcoat 1 Centre pane 1.07W/m ² k warm edge spacer	1.4 W/m ² K
B rated or Uw 1.4W/m ² k		Alitherm 400 TBT	Double glazed 28mm unit clear/argon/softcoat 1 Centre pane 1.068W/m ² k warm edge spacer	1.4 W/m ² K

Glass type 1.2 -examples K glass S, Planitherm Total, Climaguard A+, Glass type 1 -examples Pilkington S1, Planitherm one, Climaguard 1

New Build U Values with Double Glazing

(Limiting U Value 1.6 W/m²k)

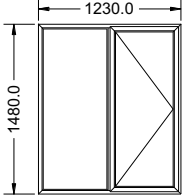
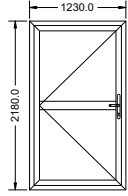
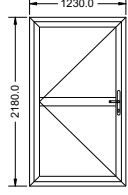
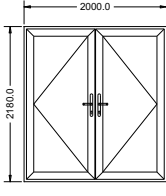
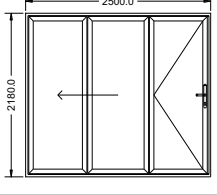
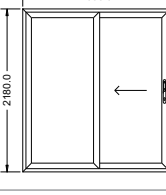
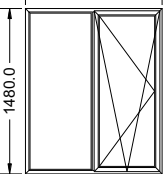
REQUIREMENT	WINDOW/DOOR DESIGN	SYSTEM	DOUBLE GLAZED UNIT SPEC	ACTUAL UW/UD
Uw 1.6 W/m ² k minimum Uw 1.2 W/m ² k Target		NEW PRODUCT Alitherm 400 Window (F)	28mm unit clear/argon/softcoat 1 Centre pane 1.068 W/m ² k warm edge spacer	1.4 W/m ² K
		NEW PRODUCT Alitherm Heritage	28mm unit clear/argon/softcoat 1 Centre pane 1.068 W/m ² k warm edge spacer	1.4 W/m ² K
>60% glazed door Ud 1.6 W/m ² k minimum Ud 1.2 W/m ² k Target		NEW PRODUCT Alitherm 400 Resi Door (F)	40mm unit clear/softcoat /softcoat Centre pane 0.72 W/m ² k warm edge spacer	1.1 W/m ² K
>60% glazed door Ud 1.6 W/m ² k minimum Ud 1.2 W/m ² k Target		NEW PRODUCT Heritage 60	36mm unit clear/softcoat /softcoat 1 Centre pane 0.7 W/m ² k Warm edge spacer	1.2 W/m ² K
Ud 1.6 W/m ² k minimum Ud 1.2 W/m ² k Target		NEW PRODUCT Alitherm 400 French Door (F)	28mm unit clear/argon/softcoat 1 Centre pane 1.068 W/m ² k warm edge spacer	1.4 W/m ² K
Ud 1.6 W/m ² k minimum Ud 1.2 W/m ² k Target		Visofold Slim 1000 Bi-fold door	28mm unit clear/argon/softcoat 1 Centre pane 1.068 W/m ² k warm edge spacer	1.6 W/m ² K
Ud 1.6 W/m ² k minimum Ud 1.2 W/m ² k Target		Visoglide Plus Sliding Door (F)	28mm unit clear/argon/softcoat 1 Centre pane 1.068 W/m ² k warm edge spacer	1.4 W/m ² K
Uw 1.6 W/m ² k minimum Uw 1.2 W/m ² k Target		Alitherm 400 TBT	28mm unit clear/argon/softcoat 1 Centre pane 1.068 W/m ² k warm edge spacer	1.4 W/m ² K

New Build U Values with Triple Glazing Notional Method

(Target U Value 1.2 W/m²k)

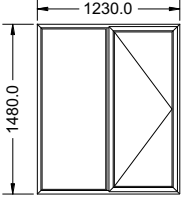
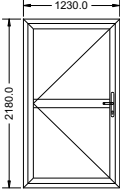
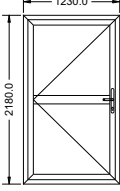
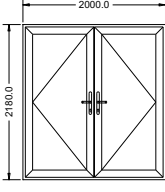
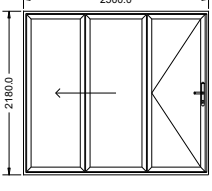
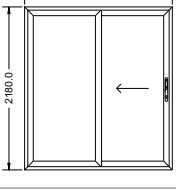
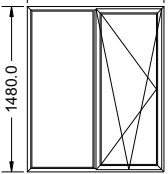
REQUIREMENT	WINDOW/DOOR DESIGN	SYSTEM	TRIPLE GLAZED UNIT SPEC	ACTUAL UW/UD
Uw 1.6 W/m ² k minimum Uw 1.2 W/m ² k Target		NEW PRODUCT Alitherm 400	40mm unit clear/softcoat 1/softcoat Centre pane 0.72 W/m ² k warm edge spacer	1.1 W/m ² K
		NEW PRODUCT Alitherm Heritage	40mm unit clear/softcoat 1/softcoat Centre pane 0.72 W/m ² k warm edge spacer	1.1 W/m ² K
>60% glazed door Ud 1.6 W/m ² k minimum Ud 1.2 W/m ² k Target		NEW PRODUCT Alitherm 400 Resi Door (F)	40mm unit clear/softcoat /softcoat Centre pane 0.72 W/m ² k warm edge spacer	1.1 W/m ² K
>60% glazed door Ud 1.6 W/m ² k minimum Ud 1.2 W/m ² k Target		NEW PRODUCT Heritage 60	36mm unit clear/softcoat /softcoat 1 Centre pane 0.7 W/m ² k Warm edge spacer	1.2 W/m ² K
Ud 1.6 W/m ² k minimum Ud 1.2 W/m ² k Target		NEW PRODUCT Alitherm 400 French Door (F)	40mm unit clear/softcoat /softcoat Centre pane 0.72 W/m ² k warm edge spacer	1.1 W/m ² K
Ud 1.6 W/m ² k minimum Ud 1.2 W/m ² k Target		Visofold Slim 1000 Bi-fold door NEW BEAD	44mm unit clear/softcoat /softcoat Centre pane 0.65 W/m ² k warm edge spacer	1.2 W/m ² K
Ud 1.6 W/m ² k minimum Ud 1.2 W/m ² k Target		Visoglide Plus Sliding Door (F)	36mm unit clear/softcoat /softcoat Centre pane 0.81 W/m ² k warm edge spacer	1.2 W/m ² K
Uw 1.6 W/m ² k minimum Uw 1.2 W/m ² k Target		Alitherm 400 TBT	36mm unit clear/softcoat 1/softcoat Centre pane 0.81 W/m ² k warm edge spacer	1.2 W/m ² K

AD L: Energy Efficiency - New Dwellings

The Notional dwelling Target 'U' Values for Windows and Doors are laid out in Table 1.1 of the Approved Document L.

The notional method enables Architects to trade off 'U' values against other materials in the dwelling as long as they are within the limiting 'U' values.

Table 1.1 from Doc L

DESCRIPTION	TARGET 'U' VALUE
Windows	1.2 W/m ² K
Doors with glazed area greater than 60%	1.2 W/m ² K
Other doors	1.0 W/m ² K

Table 4.1 from Doc L

DESCRIPTION	LIMITING 'U' VALUE
Windows	1.6 W/m ² K
Doors	1.6 W/m ² K

The lowest specification 'U' Value allowable referred to as the Limiting 'U' Values are shown in Table 4.1.

AD L: ENERGY EFFICIENCY - EXISTING DWELLINGS

'U' Values, Window Energy Ratings (WER) and Doorset Energy Ratings (DSER) of replacement windows and doors must be both:

- No worse than that of the element being replaced
- Meet the limiting standards in Table 4.2 (Lowest specification of 'U' Value or WER/DSER allowable)

Table 4.2 from Doc L

DESCRIPTION	'U' VALUE	WER/DSER
Windows	1.4 W/m ² K	B
Doors with glazed area greater than 60%	1.4 W/m ² K	C
Other doors	1.4 W/m ² K	B

'U' Values, Any windows and doors replaced will need to be at least the level of performance detailed in Table 4.2 above.

Fresher, Cleaner Indoor Air (PART F)

TTF SLIMLINE

- Independently tested to BS EN 13141-1:2019
- Water tightness of 400pa
- Independently acoustically tested in accordance with BS EN 20140-10:1992, ISO 140-10:1991.
- Tested in accordance with BS EN 1026:2016 & BS EN 1027: 2016 Weather performance

BIFOLD FLUSH-FITTING SASH TRICKLE VENT

- Stats needed

AD F: VENTILATION - NEW DWELLINGS

Table 1.7 from Doc F

ROOM TYPE	MINIMUM EQUIVALENT AREA OF BACKGROUND VENTILATORS FOR DWELLINGS WITH MULTIPLE FLOORS	MINIMUM EQUIVALENT AREA OF BACKGROUND VENTILATORS FOR SINGLE STORY DWELLINGS
Habitable Room (see note 2 & 3)	8,000mm ²	10,000mm ²
Kitchen (see note 2 & 3)	8,000mm ²	10,000mm ²
Utility Room	NO MINIMUM	NO MINIMUM
Bathroom (see note 4)	4,000mm ²	4,000mm ²
Sanitary Accommodation	NO MINIMUM	NO MINIMUM

The use of this table is not appropriate in the following situations or conditions and expert advice must be sought.

- If the dwelling has only one exposed facade (e.g. within a multi-storey building).
- If the dwelling has 70% of its openings on the same facade.
- If a kitchen has no windows or external facade where a ventilator could be installed.
- Where a kitchen and living room accommodation are not separate rooms (i.e. open plan), no fewer than three ventilators of the same equivalent area as for other

habitable rooms should be provided within the open plan space (8,000mm²).

- The total number of ventilators installed in the dwelling's habitable rooms and kitchen/s should be no fewer than five, except in one bedroom properties where there should be no fewer than four.
- If a bathroom has no window or external facade through which a ventilator can be installed, the minimum equivalent area specified should be added to the ventilator sizes specified in nearest adjoining rooms. (i.e. 8,000mm² increased to 12,000mm² and 10,000mm² increased to 14,000mm²).

AD F: VENTILATION - REPLACEMENT WINDOWS

If the existing windows have background ventilators, the replacement windows should have background ventilators that are:-

- No smaller than the background ventilators in the original windows.
- Be controllable either automatically or by the occupant.

If the existing windows do not have background ventilators and there is no mechanical ventilation with a heat recovery system, it is necessary to ensure that the ventilation provision in the dwelling is no worse than it was before the work was carried out.

This may be demonstrated in any of the following ways:-

- Incorporating background ventilators in the replacement windows equivalent to column one in the above table 1.7.
- If there is a continuous mechanical extract ventilation, replacement windows in habitable rooms which are not wet rooms must have a minimum background ventilation area of 4,000mm².
- Other ventilation provisions, if it can be demonstrated to a building control body that they comply.

Note: If it is not technically feasible to adopt the minimum equivalent areas set out in the above table 1.7, the background ventilators should have equivalent areas as close to the minimum value as is feasible.

Building Regulation Compliance, Window Energy Ratings (WER) and Doorset Energy Ratings (DSER)

Compliance with current Building Regulations is a vital part of every installation and can sometimes be complex.

Using REAL Aluminium, meeting the requirements of Part L of current UK Building Regulations, is easy as the entire range is compliant using energy ratings for renovations to existing properties when installed with a double-glazed unit with a U Value of 1.2 W/m²K and a solar gain of 0.71

or better that is manufactured using an Edgetech Super Spacer Bar or equivalent. All REAL Casement Windows achieve an 'A'-rating if the aforementioned glass unit is upgraded to low-iron glass.

The thermal efficiency of the REAL Aluminium range can be enhanced further by using higher-performance double-glazed or triple-glazed units.

REAL Aluminium WER, DSER & U Values

WER: Window Energy Performance Certificate
WER Window Energy Rating - In accordance with Approved Document L

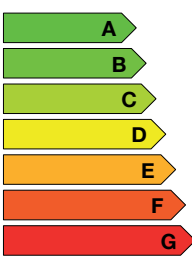

A

Company
Customade/REAL

Project
REAL Alitherm 400i Window

Date
14 Jul 2022

BFR System
SC010

BFR Manufacturer
**M117
M117**

BFR Simplified Energy Licence
SEL

WER:	Window Energy Rating: 196.74((1-f)xgglass) - 68.5 x (U + (0.0165 xAL))	3.2 kWh/m²/Year
Thermal Transmittance:	WER U Value of window calculated using the methods and conventions set out in BR443 Whole window U Value with frame, glazing and glass spacer bar combined. Standard window configuration set out by BR443/GGF 2.3 U Window: 0.496+0.919+0.143	
Frame:	Supplier: Smart Architectural Aluminium System: Alitherm 400 KB Outer Frame: ETC4110F (1.556) Vent Frame: ETC4129F (2.218) Transom Mullion: ETC4130F (2.112) Heat Transfer: 2.024 W/m ² K x (24.5% Frame)	0.496 W/m²K
Glazing:	Supplier: Glass Systems Specification: 4/20/4 Clear Softcoat Low Iron 1.2 CPV Centre Pane, g Value: 1.217 W/m ² K, 0.74 Heat Transfer: 1.217 W/m ² K x (75.5% Glass)	0.919 W/m²K
Spacer:	Supplier: Edgetech Spacer Bar: Super Spacer Premium Heat Transfer: 0.035 W/m ² K x (4.092m/m ²)	0.143 W/m²K
U Value:	Window U Value: Calculation to BR443/GGF 2.3	1.6 W/m²K



Calculated in accordance with UK Building Regulations Document L and BR443
BS EN ISO 10077-2, Thermal performance of windows, doors and shutters.
Calculation of thermal transmittance, Part 2, Numerical method for frames

Version 6.0 (0327)

U Value: Certificate
Window U Value - In accordance with Approved Document L

U Value

1.2 W/m²K

Company
Customade/REAL

Project
REAL System 1 - Triple glazed window

Date
14 Jul 2022

BFR System
SC010

BFR Manufacturer
**M117
M117**

BFR Simplified Energy Licence
SEL3310

WER:	Window Energy Rating: 196.74((1-f)xgglass) - 68.5 x (U + (0.0165 xAL))	-18.4 kWh/m²/Year
Thermal Transmittance:	WER U Value of window calculated using the methods and conventions set out in BR443 Whole window U Value with frame, glazing and glass spacer bar combined. Standard window configuration set out by BR443/GGF 2.3 U Window: 0.566+0.531+0.125	
Frame:	Supplier: Smart Architectural Aluminium System: Alitherm 300 Outer Frame: *ZSB169FF (1.915) Vent Frame: ETC424N (2.947) Transom Mullion: ETC333 (3.104) Heat Transfer: 2.699 W/m ² K x (21.0% Frame)	0.566 W/m²K
Glazing:	Supplier: Glass Systems Specification: 4/12/4/12/4 clear/softcoat 1/softcoat 1 0.7 CPV Centre Pane, g Value: 0.672 W/m ² K, 0.42 Heat Transfer: 0.672 W/m ² K x (79.0% Glass)	0.531 W/m²K
Spacer:	Supplier: Edgetech Spacer Bar: Super Spacer Premium Heat Transfer: 0.030 W/m ² K x (4.165m/m ²)	0.125 W/m²K
U Value:	Window U Value: Calculation to BR443/GGF 2.3	1.2 W/m²K



Calculated in accordance with UK Building Regulations Document L and BR443
BS EN ISO 10077-2, Thermal performance of windows, doors and shutters.
Calculation of thermal transmittance, Part 2, Numerical method for frames

Version 6.0 (0323)



Note:

All REAL Aluminium products when used in conjunction with the glass specifications on pages 8,9,10 and 11 satisfy current Building Regulations Part L for refurbishment and new-build applications.

The addition of low-iron glass will not improve U Values but will improve WER/DSER rating due to solar gain.

The addition of triple glazing will improve U Values but due to reduced solar gain has limited effect on WER/DSER ratings.

SPECIFICATION REAL SYSTEM 1 & 2

System	Modified 70mm Alitherm 300
Finish	Polyester powder coated
WER	up to A-rating using suitable double-glazed unit
U Value	up to 1.2 w/m ² k using suitable triple-glazed unit
Locking system	Espag locking
Frame depth	70mm
Typical sightline	67mm
SH Max o/a width	700mm
SH Max o/a height	1400mm
TH Max o/a width	1400mm
TH Max o/a height	1300mm
Glazing	28mm double-glazed or 36mm triple-glazed

SPECIFICATION VISOGLIDE PLUS

System	Visoglide Plus
Finish	Polyester powder coated
U Value	up to 1.3 w/m ² k using a suitable triple-glazed unit
Security	Multi-point locking plus individual keeps
Frame depth	99mm or 126mm double track 165.5mm or 182.5mm triple track
Max sash weight	200kg
Max sash height	2500mm
Max sash width	Within above limitations
Glazing	28mm double-glazed or 36mm triple-glazed
Track	Double or triple dependent on configuration

SPECIFICATION ALITHERM 400 WINDOW

System	Alitherm 400*
Finish	Polyester powder organic coating to BS6496
WER	down to A+ rating using suitable double glazed unit
U Value	down to 1.1 w/m ² k with triple-glazing
Handles	Espag locking handles by ERA
Frame depth	70mm
Typical sight line	71.5mm
SH Max o/a width	864mm
SH Max o/a height	1400mm
TH Max o/a width	1400mm
TH Max o/a height	1500mm
Glazing	28mm double glazed or 40mm triple glazed

*Externally glazed and triple glazed windows require wedge gasketing.

SPECIFICATION ALITHERM 400 DOOR

System	Alitherm 400
U Value	up to 1.1 w/m ² k using a suitable triple-glazed unit
Security	Multi-point locking & 3 star cylinder
Max height	2400mm
Max width	1100mm
Max weight	100kg
Glazing	28mm double-glazed or 40mm triple-glazed

SPECIFICATION VISOFOLD 1000 SLIM

System	Visofold 1000 Slim Quick-Glaze Tap In Bead
Finish	Polyester powder coated
U Value	up to 1.2 w/m ² k using suitable triple-glazed unit
Security tested	PAS 24: 2016 enhanced security-rated doors on a three-pane open-out door
Weather tested	BS 6375 Part 1: 2009
Security	Multi-point locking with shootbolt
Frame depth	70mm
Typical sight line	122mm
Max sash weight	100kg
Max o/a height (per sash)	2500mm
Max o/a width (per sash)	1200mm*
Glazing	28mm double-glazed or 44mm triple-glazed

*Triple glazed doors require wedge gasketing.

REAL

ALUMINIUM

www.re-aluminium.co.uk

01453 826884

enquiries@real-aluminium.co.uk

REAL Aluminium,
Newton Centre, Brunel Way,
Stroudwater Business Park,
Stonehouse, GL10 3SW

The information provided in this publication is provided 'as is' in April 2023. REAL Aluminium may modify and change the information and specifications from time to time for a variety of reasons, without prior notice and updates will not be issued automatically. Due to the limitations of the processes of printing or digital display of colours, no liability can be accepted for the accuracy, they are intended as guidance only. The information is not intended to have any legal effect, whether by the way of advice, representation or warranty, expressed or implied. All rights reserved. Copyright in this publication belongs to REAL Aluminium, and all such copyright may not be used, sold, copied or reproduced in whole or part in any manner in any media to any person without prior consent. Copyright ©2022 REAL Aluminium. All rights reserved.

V3 - MAY 2024

Part of the
 Customade Group

www.customade.co.uk